

MAKE *and* MEND

FOR VICTORY ★ BOOK NO. S-10 ★ PRICE 10 CENTS



Make and Mend

CONSUMER'S VICTORY PLEDGE:

"As a consumer, in the total defense of democracy,-I will do my part to make my home, my community, my country ready, efficient, strong.

I will buy carefully — and I will not buy anything above the ceiling price, no matter how much I may want it.

I will take good care of the things I have — and I will not buy anything made from vital war materials which I can get along without.

I will waste nothing — and I will take care to salvage everything needed to win the war."

CONSUMER DIVISION,
Office of Price Administration

It's up to you to keep the home fires burning, to see that you and your family stay easy-on-the-eyes. Fortunately, you can be patriotic and pretty both. It's easy to teach an old wardrobe new tricks, to resurrect the skele-

tons in your closet and bring them up to date. Come on, take those old knockabouts and turn them into knockouts, keep that glint in Uncle Sam's eye and still do your stint towards Victory!

TABLE OF CONTENTS

<p>I In The Basket Page 4 What You Need in Your Sewing Basket and How to Conserve What You Have</p> <p>II Life Extension Page 5 How to Mend and Patch</p> <p>III Fit For Anything Page 9 Alterations and Restyling</p> <p>IV Variety Is The Spice Of Life Page 13 a. White Collar Class (Dick-eyes and collars) Page 14 b. Smart Headwork (Hats to make and remake) Page 18 c. Telling Trifles (Accessories from scraps of yarn, cotton and fabric) Page 26</p>	<p>V Cutting Up In A Big Way Page 31 a. You Have the Goods on Him (How to convert a man's suit into a woman's suit) Page 32 b. The Shirt Off His Back (Interesting ways to use men's shirts to good advantage) Page 40 c. There's Life in the Old Girl Yet (Suggestions for restyling women's and girls' clothing) Page 43 d. Junior Editions (How to make attractive clothes for young folks) Page 44</p> <p>VI How To Reclaim Used Wool Page 47</p> <p>VII Suggestions For Easy Sewing Page 48</p> <p>VIII List Of Materials Page 50</p>
-------------------------------------------------------------------------------------------------------------------------------------------------------------------------------------------------------------------------------------------------------------------------------------------------------------------------------------------------------------------------------------------------------------------------------------------------------------------------------------------------------------------------------------------------------	--------------------------------------------------------------------------------------------------------------------------------------------------------------------------------------------------------------------------------------------------------------------------------------------------------------------------------------------------------------------------------------------------------------------------------------------------------------------------------------------------------------------------------------------------------------------------------------------------------------------





In the Basket

WHAT YOU NEED IN YOUR SEWING BASKET — AND HOW TO CONSERVE WHAT YOU HAVE . . .

Sewing Needles . . . Buy needles of superior material. Milward's, made of hand ground steel, have a smoothly finished eye which prevents the thread from fraying, a sharp smooth point which does not catch in the fabric. There is a size and type for every kind of sewing. See chart on p. 50.

Care of Needles . . . To preserve needles from rust, cut a strip of woolen material, wide enough to accommodate the longest needle and long enough to hold the number of needles ordinarily used. Pink the edges. Fold at center a piece of tape or ribbon six inches long, and sew fold to center edge of width of piece. Stick needles on this woolen material when they are not being used. Roll it up and tie it.

To sharpen needles use an emery, a small bag often made in the shape of a strawberry. Needles will rust if allowed to remain sticking in it.

Crochet Hooks and Knitting Pins . . . Have a selection of these tools in the sizes you are most likely to use. Small and attractive accessories can be made quickly and easily with them.

Thread . . . There is a thread for every purpose and it is wise to have an assortment on hand. Make a list of your ordinary sewing problems and consult the chart on p. 50 to see what you should have. It is a waste of time and energy, if you have to run to the store every time you decide to sew.

Care of Thread . . . To avoid knotting and fraying, use the correct length of thread, about eighteen inches, or the distance from the middle finger to the elbow. To prevent thread from unrolling from the spool, always tuck end in notch provided at outer edge. If this notch becomes broken, it is a simple matter to cut a new one with a razor blade.

Scissors . . . Buy the best scissors and shears you can afford. If you can have only one, buy good scissors about 8" in length. If you do much sewing, dressmaker's shears or pinking shears, 8" in length, are a necessity. A small scissors is handy for cutting buttonholes, ripping seams and snipping thread.

Care of Scissors . . . Scissors for sewing must not be used to cut materials other than fabrics and thread. Paper dulls them badly. Keep scissors clean, as dust and dirt dull them. Apply frequently a drop of lubricating oil at the joint.

Pins . . . Brass dressmaker pins, sizes 5 and 6 are very good. Pins of inferior quality spoil the fabric in which they are used.

Care of Pins . . . When you are using pins, wear a small pincushion held at the left wrist with an elastic. In this way, as soon as pins are removed, they may be salvaged very easily. Pins are hard to get, and if you pick them up and save them you are helping the war effort.

A Tape Measure and a Yardstick are useful and necessary if you intend to sew.

Zippers, Buttons, and Snaps . . . When you are discarding articles of clothing, look at the zippers, buttons and snaps. If they are still good, cut them off and use them again.

Scraps of Fabric, Thread and Yarn . . . Do not discard your scraps. This book has many attractive suggestions for their use.

Life Extension

HOW TO MEND AND PATCH

You've no idea how quickly wilted wardrobes respond to kindness. Try the needle-and-thread treatment for that "just stepped out of a handbox" look. Your girdles will keep you in shape indefinitely if you apply First Aid in time; with skillful mending your stockings will outlast all their contemporaries; and a judicious—and gallant—patch will keep many a dress going to a ripe old age.



STOCKINGS

General Directions . . . Many things that can be done to lengthen the usefulness of stockings are described below. When you need to use darning thread, see p. 50 for correct threads. Separate strands according to weight of stocking. Choose a shade a little darker than stocking as thread works in lighter. Use a darning egg. (Fig. 1). Darn on right side.

To Make Stockings Last Longer

1. Buy two pairs of the same color at one time in the correct size, in a weight suitable to their use, and length in accordance with the length of leg and of girdle.
2. Buy rayon stockings as follows:
 - a. Buy cotton reinforced toes—or reinforce on wrong side with cotton darning thread, weaving back and forth with small running stitches.
 - b. Buy leg length about 2" shorter than silk or nylon—they are apt to stretch.
3. Put stockings on carefully.
 - a. Roll down to the toe and draw them up easily. Take care not to pull threads with rings, bracelets, cuticle, etc.
 - b. Always fasten garters in double hem. If back garter comes at opening in double hem, sew this up.

- c. Fasten lisle stockings more loosely than others, as they do not have the same elasticity.
4. Launder stockings carefully after each wearing in lukewarm water with mild soap flakes. Do not dry near heat. Allow to dry completely. Rayon stockings should be allowed to dry 48 hours.
 5. Examine for worn places and repair as follows:
 - a. Reinforce worn places in foot with small running stitches parallel to weave.
 - b. Mend split seams with an over and over stitch.
 - c. Bring pulled threads through to wrong side and secure with tiny stitches to prevent runs.

Darning a Hole . . . With stocking right side out, insert egg under hole. Trim ragged edges of hole. Do not use a knot and make lengthwise threads first. Leaving a short end free, take a few running stitches far enough from the hole to take in all the worn part. Turn, leaving a small loop at turning. On each succeeding row increase number of stitches so that when you come to the hole, you will cover it and also strengthen the worn part. Arrange stitches so that needle comes out over edges of hole. Decrease length of rows on other side of hole. Cut thread when finished and turn darn around. Weave stitches in the same way across the width over and under foundation stitches already made (Fig. 2).

Mending Runs . . . Thread machine with matching mercerized thread. Turn stocking wrong side out. Fold so that run is on fold. Pin fold to piece of paper, stretching while pinning. Stitch by machine close to edge. Pull paper apart to free stitches. Tie and clip ends of thread.

GIRDLES

To Make Girdles Last Longer

1. When choosing a girdle:
 - a. Buy the right size—size of a step-in is your waist measurement.
 - b. Test length of garters in sitting position. If they pull, garter or stocking should be longer.
2. When putting on a girdle:
 - a. Use fleshy part of hand—not fingernails to take hold of elasticized fabric.
 - b. Fasten garters straight and in center of double hem of stocking.
3. Launder garment once a week. Rinse thoroughly and wrap it in a turkish towel. Keep it out of the sun and heat when drying.
4. Alternate wear of garments each week if you have two.
5. Examine the garment for worn places and repair as soon as they appear.

Repair

1. **Elastic Webbing**—Catch the end of each rubber thread that has pulled out and wrap it securely with J. & P. COATS HEAVY DUTY MERCERIZED SEWING THREAD so that it will hold and then darn it down into seam or fabric where it pulled out. Take care not to put your needle through any rubber threads for it will cut them. For the same reason do not stitch elastic webbing on the machine.
2. **Fagotting** — Use J. & P. COATS HEAVY DUTY MERCERIZED THREAD and a catch stitch (see p. 49).
3. **Seams**—Sew twill tape or satin fabric as a reinforcement on under side. When sewing on elasticized fabric catch stitch is always best to use because it has more "give."
4. **Garters**—
 - a. If only stitching has been broken, re-stitch.
 - b. If rubber is lifeless, cut garters off and replace with new ones.
 - c. If you cannot easily put the new garters between the double fabric, sew them onto the under side of garment and finish off with a tape or satin ribbon for additional reinforcement.

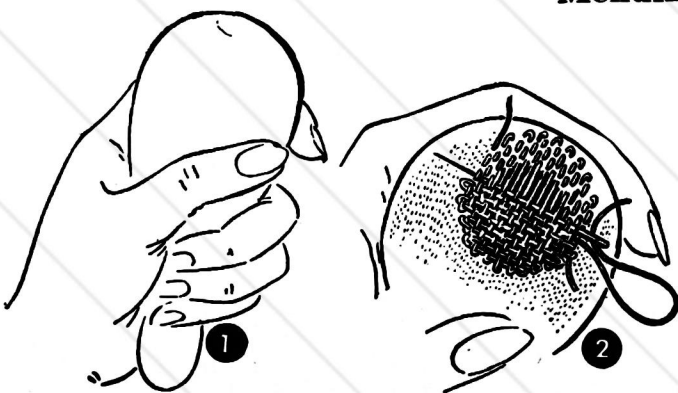

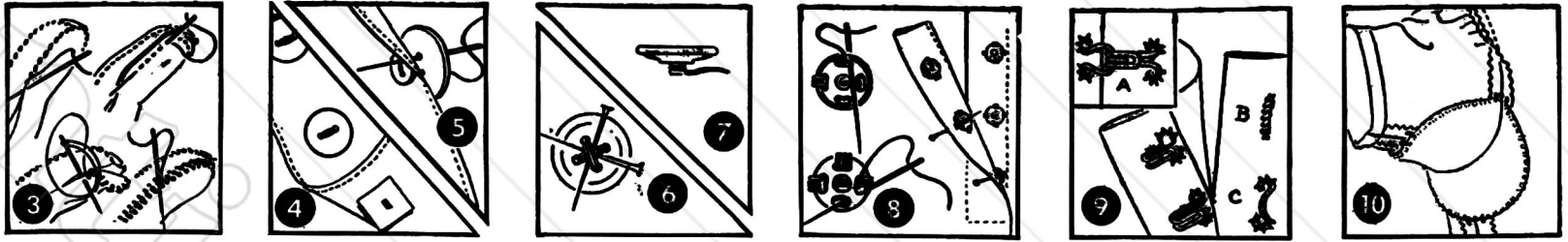

GLOVES

Split seams in gloves are mended in manner of original stitching — in whip stitch or running stitch. For heavy leathers, pigskin, capeskin, calf, use matching J. & P. COATS HEAVY DUTY MERCERIZED THREAD. CLARK'S O.N.T. BRILLIANT is suitable for cotton, doeskin, etc. On lapped seams, sewed close by machine, if there is not enough for a seam, it is possible to make blanket stitches along edges of ripped seam to strengthen it. Use Mercerized Thread in a matching shade. Draw edges together by overhanding through the blanket stitches (Fig. 3). Start without a knot, securing ends of stitching carefully and concealing all thread ends inside glove.

FASTENERS

General Directions . . . Use Button and Carpet Thread for sewing buttons on men's and boys' heavy clothes. Use Heavy Duty Thread for fabrics with firm body. If there is unusual strain on a button or it is sewed to a single thickness of fabric, reinforce with a piece of garment fabric, folded into a square, and sewed on wrong side as button is sewed on (Fig. 4). Small buttons are used to reinforce buttons on overcoats (Fig. 5).

Buttons . . . Lap garment, and mark with a pin a point 1/8" from the end of buttonhole nearest edge. Using a double thread, knotted, insert needle from right side at marked point. Place button in position over knot and anchor in place by sewing through shank. If button has holes, after first stitch place a pin across top under thread to keep it loose (Fig. 6). After sufficient stitches have been taken through holes, remove pin and wind thread between button and fabric several times to form a shank (Fig. 7). Bring thread to wrong side, take several small stitches, and run thread between two thicknesses of fabric before clipping.

Snaps . . . Sew snap fasteners with an over and over stitch using double thread and concealing knot under snap. Sew each hole separately and carry thread on wrong side of garment to next hole (Fig. 8). Place snaps not more than 2" apart. Attach flat side first. Hold garment closed to mark point for other half of snap.

Hooks and Eyes . . . Sew hooks and eyes with double thread and an over and over stitch through holes. Sew over hook near top to hold it down. The straight metal bar, or thread bar worked with a blanket stitch is placed on seam line. The curved eye extends slightly beyond edge of opening (Fig. 9).

AIDS TO GOOD GROOMING

DRESS SHIELDS

Secure shields in desired position with invisible stitches, taking stitches only through finished edge of shield. Tack shield at each end of curved seam to under armhole seam, leaving it loose enough that it will not pull when garment is on. Tack shield also to side and sleeve seams (Fig. 10). For coats and suits, use dark shields or cover them with lining material.

BELT LOOPS

Mark half the width of belt above and below waistline. Using double thread, knot ends, and insert needle through seam from wrong side at top marking. Reinforce this point with small buttonhole stitch (see p. 49). Make large loop by taking another stitch in same place. Do not draw stitch all the way through. Place thumb and forefinger in loop. Using forefinger, draw thread through loop, thus making another loop. Draw this loop out, tightening first one (Fig. 11). Continue chain of loops to desired length. Pass needle through last loop and draw thread tightly to close chain. Insert needle in seam at second marking, draw through to wrong side, and fasten securely.

SPLIT SEAMS

If possible, stitch seam from wrong side by machine. In lined coats, seam is mended with an invisible stitch from right side. Insert needle 1" from beginning of split. (Knot is clipped when mending is finished.) On opposite edge of opening and directly across, catch 2 or 3 threads on needle. Continue to catch 2 or 3 threads alternately on either side of split (Fig. 12). Keep stitches very small. Pull thread up from time to time. Fasten off invisibly and run thread end on inside for 1" before clipping.

LINGERIE STRAPS

To prevent straps from breaking or being troublesome, make a band 1 1/2" long of single crochet (use CLARK'S O.N.T. MERCERIZED THREAD doubled), of narrow tape, or of narrow bands of dress fabric. Sew one end to shoulder seam half way between armhole and center of shoulder seam. Sew flat side of a small snap to free end, and other side of snap to shoulder seam directly over the top half of snap (Fig. 13).

TURNING THE COLLAR AND CUFFS ON A MAN'S SHIRT

Determine exact center of collar and neckband by folding them in half, matching edge to edge and point to point. Mark center of each with pin. On *wrong* side of collar run a basting thread down the center (Fig. 14). On *inner* side of neckband run a colored basting down the center (Fig. 15). Remove collar from top of neckband by ripping stitching carefully (Fig. 16). Pull out all thread ends. Press neckband (seams still turned in) and collar section well. Insert reversed collar in neckband, matching centers carefully. Pin from center out, making same seam allowance as before. Do not stretch band or collar. Ease wherever necessary.

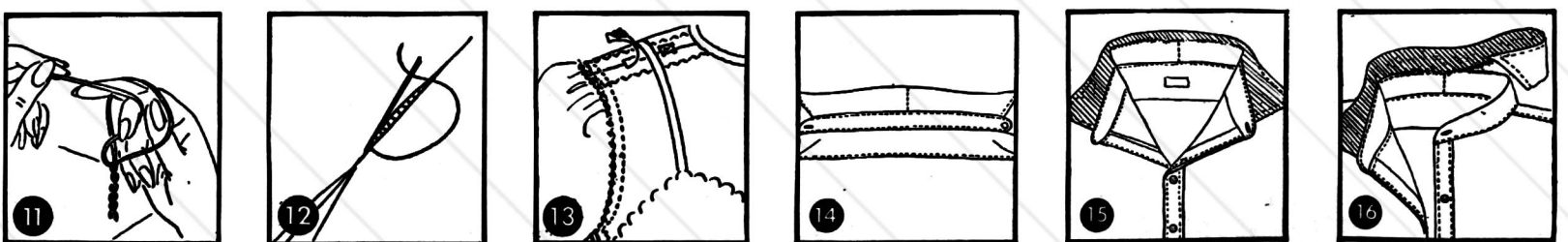

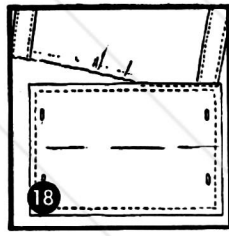
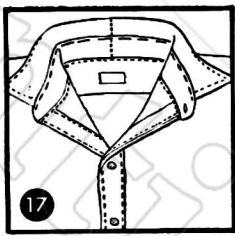

Baste both sides of neckband to collar along old stitching line (Fig. 17). Stitch by machine from inside around edge using a small stitch.

Occasionally the collar facing varies slightly from the rest of the shirt in that it is cut on the opposite grain. This is scarcely noticeable when the shirt has been carefully laundered. It is practical to turn cuffs only when they fold back. Remove cuff by ripping stitching across top (Fig. 18). Press. Ease sleeve into turned cuff. Baste and stitch on outside.

MENDING TEARS

General Directions . . . For woolsens, a thread of fabric drawn from the hem or side makes a neat and inconspicuous darn. Otherwise use CLARK'S O.N.T. and J. & P. COATS MERCERIZED THREAD which comes in many shades so that it is easy to secure a matching color. Darn on right side. Do not make a knot as there is no strain on material.

Straight Tear . . . To begin, bring thread through from wrong

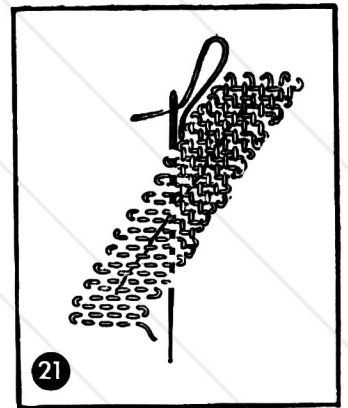
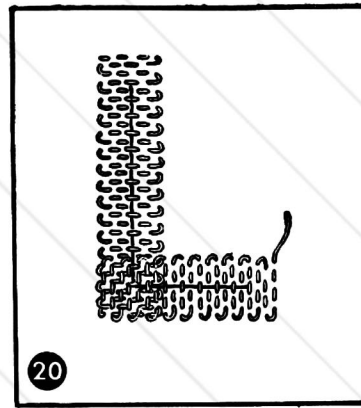
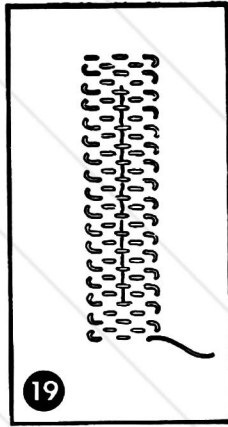

side of garment, leaving an end of 6" on wrong side, about 1/4" beyond end of tear and a little to the right. Following the thread of goods, take a few rows of small running stitches back and forth. Do not darn too tightly but leave a very small loop at each turning. When you reach the tear, fit edges together and sew across opening. On one row make the stitch over tear and on next row under. Continue for about 1/4" beyond end. To finish, catch thread through stitches of last row and clip. Thread needle with 6" thread left hanging at beginning and catch it through stitches of at least one row. Clip closely (Fig. 19).

Three Cornered Tear . . . Tear is both lengthwise and crosswise. Darn in same manner as for straight tear. Stitches run at right angles to opening. Begin at one end and darn

one side completely. Then begin at other end and darn that side completely. Stitches at corners thus overlap and are strengthened (Fig. 20).

Diagonal Tear . . . In a diagonal tear both lengthwise and crosswise threads are cut. Darn with small running stitches parallel to lengthwise thread, but in direction of tear. Over these stitches work another set at right angles to first (Fig. 21).

Worn Place On Garment . . . Cut piece of material same as garment just a little larger than worn place. Baste to wrong side under thin spot, and cover entire worn area as for darning a tear, taking stitches through both thicknesses of material. On wool material, if a similar piece of fabric is not available, baste a piece of net under worn spot and darn as for tear.

PATCHES

General Directions . . . When hole is large, and a darn would be too conspicuous and not strong enough, the hole is patched with material same as garment. Cut a piece from hem or seams to obtain matching patch. If necessary, fade patch to correspond by washing in soap suds and baking soda, rinsing well, and drying in the sun.

Hemmed Patch . . . Using threads of material as guide, cut away worn portion to make either a

square or rectangle (Fig. 22). Cut patch 1" larger on all sides than hole after edges have been straightened. Pin patch in place under hole, right side showing through. Threads in patch must run same way as those in garment, and any pattern should match exactly. On right side of garment clip corners of hole diagonally about 1/4". Turn in raw edges and baste to patch (Fig. 23). On wrong side of garment turn in raw edges of patch 1/4" and baste to garment (Fig. 24). Press. Stitch edges down by machine or hand hem (Fig. 25).

Darned Patch . . . Inconspicuous, used on woolsens . . . Cut away worn portion as for hemmed patch. Cut patch 1" larger than hole. Do not clip corners of hole. Raw edges of the hole are basted to patch and then darned to patch with rows of small running stitches as in darn for straight tear. (Use thread drawn from hem or side.) Darn each side completely so that stitches overlap at corners (Fig. 26). Remove basting. Do not sew raw edges of patch to garment on wrong side. Finish these edges with overcast stitch (Fig. 27).

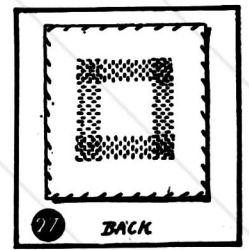
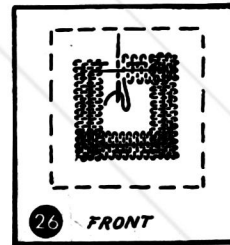
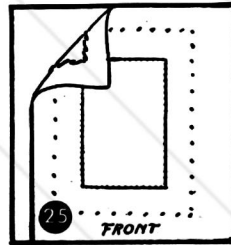
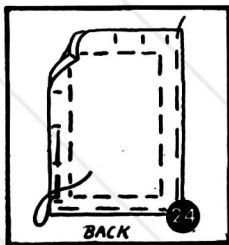
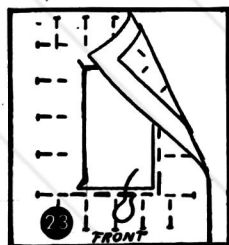

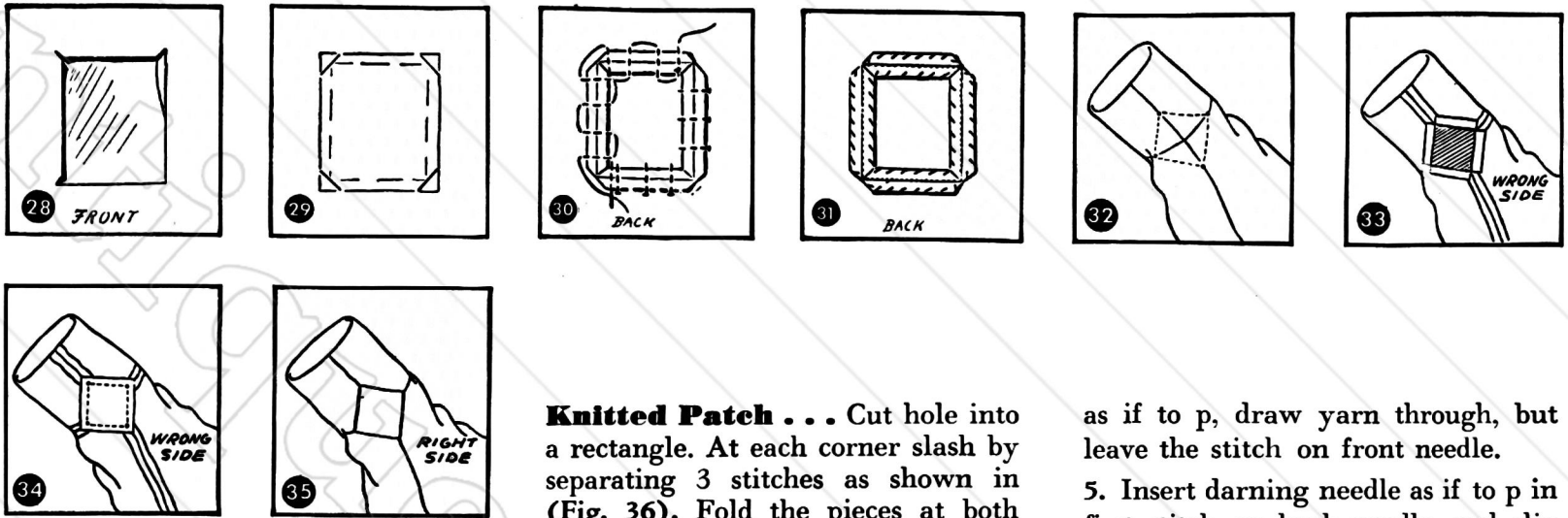

Overhand Patch . . . *Least noticeable (not very strong).* Straighten hole as for hemmed patch. Clip corners diagonally for $\frac{3}{8}$ " (Fig. 28). Turn edges under as far as possible. Baste. Press. Measure dimensions of hole with edges turned back. Carefully match patch and cut it $\frac{3}{8}$ " larger than the hole on all sides. Turn in $\frac{3}{8}$ " allowance on one side. Press down. Do same on 3 remaining sides. With patch flat, where creases come to a point, cut off triangle of goods (Fig. 29). Put patch directly under hole. It should fit exactly. Pin in place with pins at right angles to folded edges. Baste with small stitches at these points (Fig. 30). On wrong side overhand patch to garment with tiny stitches (Fig. 31). Overcast raw edges. Remove bastings. Press.

Underarm Patch . . . Four seams meet at underarm. Cut away worn portion in a square, each corner of which comes at a seam line (Fig. 32). Straighten edges of hole. Turn dress to wrong side. Rip seams about $\frac{1}{2}$ ". Turn edges of hole back $\frac{1}{2}$ " and press (Fig. 33). Cut patch $\frac{1}{2}$ " larger all around than opening. Place patch over hole right side down. Allowing $\frac{1}{2}$ " for seam, baste edge of patch to edge of hole. Stitch on basting line (Fig. 34). Press seam open. Overcast raw edges. (Fig. 35) shows finished patch.

Knitted Patch . . . Cut hole into a rectangle. At each corner slash by separating 3 stitches as shown in (Fig. 36). Fold the pieces at both sides of opening back to wrong side of sweater. Sew neatly in place with matching yarn (Fig. 37). Place the stitches at top of hole on a stitch holder or safety pin (Fig. 38). With a double-pointed steel knitting needle pick up the stitches at bottom of hole. Attach matching yarn at right side. Double over a short end of yarn and draw a loop through first stitch and proceed as in regular knitting. Work in stockinette st (k 1 row, p 1 row) until work reaches the top of the hole, ending with a k row. Break off yarn so that a 14" length is left. Thread a darning needle with this length. Place stitches on the stitch holder or safety pin on the second knitting needle. Weave the stitches on the two needles together as follows:

1. Turn the work and hold it so that the two knitting needles have stitches even and parallel, and the strand of yarn is at the end of back needle.
2. Insert darning needle as if to p in first stitch of front needle. Draw through the yarn, leaving stitch on front needle.
3. Insert darning needle as if to k in the first stitch of back needle. Draw yarn through, leaving stitch on back needle.
4. Insert darning needle as if to k in first stitch of front needle (same stitch as before), and slip this stitch off the front needle. Insert darning needle in next stitch of front needle

as if to p, draw yarn through, but leave the stitch on front needle.

5. Insert darning needle as if to p in first stitch on back needle, and slip this stitch off. Insert darning needle in next stitch on back needle as if to k, draw yarn through but leave this stitch on needle.

6. Repeat steps 4 and 5 until all stitches are worked off.

Sew side edges neatly to the side edges of rectangle on wrong side of hole. Darn in loose end at beginning of work. Press through a damp cloth.

Abbreviations

k . . . knit p . . . purl
st . . . stitch

Appliqué for Patches . . . Holes may be cleverly hidden by means of appliqué. Cut out flowers from printed fabric allowing $\frac{1}{4}$ " edge all around. Run a loose machine stitch $\frac{1}{8}$ " from raw edge. Pull up stitching and raw edge will turn under. Baste around turned edge. Press. Slip stitch (see p. 49) in place with small invisible stitches. Original pattern or commercial transfers may also be used.

Embroidery for Patches . . . Embroidery may also be used to conceal tears and darns. Use commercial transfer patterns or plan simple embroidery which needs no pattern (monograms, saddle-stitching, lazy-daisy, cross stitch).

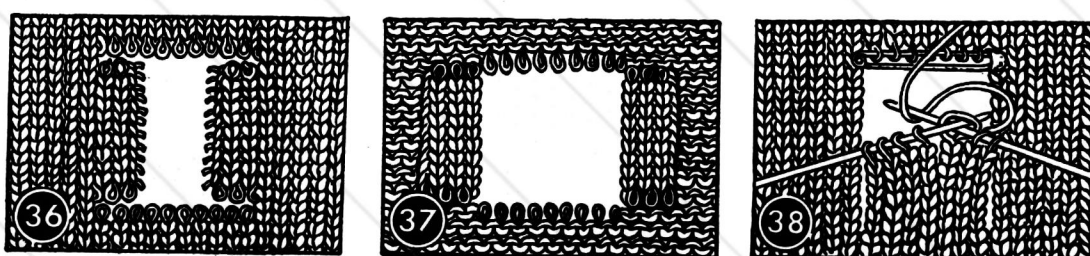

Fit for Anything



ALTERATIONS AND RESTYLING

For external use only: a thimbleful of dressmakers' tricks guaranteed to take the years off your clothes in the twinkling of a needle's eye. Nobody will ever guess the age of your coat if its hem swings straight and true, or dream your dress isn't this year's vintage if its shoulders are smooth, its collar trim. Follow these simple as ABC directions and watch your tired wardrobe put on new airs, snap to attention like brave and pretty soldiers *for service*.

Alteration frequently involves only a few simple adjustments. Dresses, skirts, and coats may need hems or sleeves lengthened or shortened, "bagginess" eliminated at the back, a waist taken in, a new lining.

Occasionally alteration entails a change of one or two objectionable features so as to restyle the garment. In this case there are a few important considerations:

1. Is the original fabric good enough to survive the change?
2. Is the color becoming? If not, can it be dyed?
3. Is the style adaptable to the change?

The general rules for this kind of alteration are as follows:

1. To make desired changes use a commercial pattern, chosen for desired new lines, but keeping in mind the existing lines of the garment.
2. Parts to be recut are ripped flat, pressed and treated as new fabric.
3. Contrasting fabric is chosen so that it is suitable to the existing garment. Do not attempt to match weaves. Rather choose a plain contrast. The same applies to colors and prints.

DRESS PROBLEMS . . . LENGTH OF DRESS

How to Alter Hems

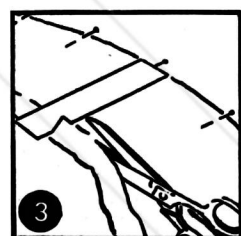
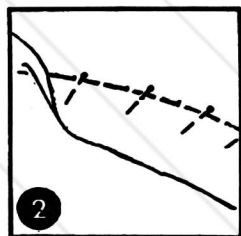
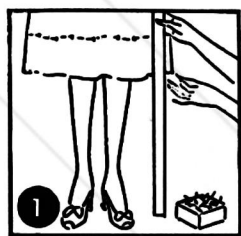

1. Take out old hem, take off old seam binding to use again. Press out crease mark from wrong side through a damp cloth. Put on garment, wearing shoes of a suitable heel height.
 2. Mark at desired hemline by having someone measure the distance from floor with a yardstick and mark it at short intervals around bottom of skirt by inserting pins parallel to floor (Fig. 1), or use a commercial skirt marker set at proper height.
 3. Turn up hem at new line by folding fabric at pin line and placing pins at right angles to fold (Fig. 2). Baste close to fold. Press on wrong side.
 4. Trim to desired width, using a gauge (Fig. 3). Two inches is an average finished width, but very full skirts should have narrower hems.
 5. Finish hem suitably.
- * For a skirt the procedure is the same as that outlined above.

Hem Finishes

1. For cottons, rayons, and other washables

where skirt is not too full, turn in raw edge $\frac{1}{4}$ " and machine stitch close to edge. Press, pin, and slip stitch (see p. 49).

2. For rayons, woolens, and skirts with some fullness, gather fullness to fit hemline by running a loose machine stitch $\frac{1}{4}$ " from edge, and pulling this up to fit. Match seams, spreading fullness evenly into the places where it wants to fall naturally, following the grain. Shrink out excess fullness by pressing through a damp cloth. Machine stitch seam binding or cotton bias trim along gathering line. Slip stitch.

3. For heavy firmly woven woolens, it is sufficient to pink (see p. 48) the hem edge, run a machine stitching close to the edge, and catch stitch in place (see p. 49).

* For a skirt the procedure is the same as that outlined above.

Hint: When lengthening the skirt, if, after cleaning and pressing, the line of the former hem persists in showing, choose a mercerized thread of matching color and machine stitch over the mark.



SPECIAL PROBLEMS IN ADJUSTING LENGTH OF DRESS

Shortening a Dress from Waistline (When Lower Edge Cannot Be Altered)

1. Determine how many inches you wish to shorten dress (see p. 9). Measure desired number of inches down from waistline all around skirt and mark with pins. Baste around marked line.
2. Rip skirt from waist and rip placket from skirt. Mark waistline on waist with basting. Mark center back and center front of waist and skirt. Rip side seams of skirt to basting line.
3. Turn under top of skirt at basting line, and matching center points, pin to waist at waistline.
4. Put on dress and check evenness of hemline. Take up or let down as necessary by turning under more or less around top of skirt.
5. Fit side seams.
6. Remove dress. Mark fold at top of skirt and new side seam lines.
7. Remove skirt and trim top edge $\frac{3}{4}$ " above marking line. Baste and stitch side seams along marking lines, graduating into old seams.
8. Rip old seams, press open, trim to $\frac{3}{4}$ ".
9. Turn in top edge of skirt along marking line. Matching centers and side seams, pin skirt to waistline. Stitch, press, insert placket.

* For a skirt, rip off belt and follow above procedure.

Shortening a Full Length Skirt

1. Hem is marked with chalk or pencil $\frac{1}{4}$ " below point where dress touches floor, when it is hanging straight. Cut off on this line.
2. Stitch back $\frac{1}{8}$ " by machine. Turn up edge another $\frac{1}{8}$ " and slip stitch (see p. 49). Or hem may be roll hemmed by hand (see p. 49). Press.

Faced Hem on a Flared Skirt

1. When there is not enough fabric to turn up, proceed as in steps 1 and 2 of *How To Alter Hems*. Baste around pin line. Cut off $\frac{1}{2}$ " below basting line.
2. Measure distance around bottom of skirt.
3. For *facing*, cut bias strips (see p. 49) 3 inches wide, of a fabric similar to that in dress.
4. Sew enough pieces together so that strip equals width at bottom of skirt.
5. Fit strip to lower edge of garment right sides together and baste. Join ends.
6. Stitch around bottom edge taking $\frac{1}{2}$ " seam. Trim seam to $\frac{1}{4}$ ". Press open.

7. Fold facing back to wrong side along seamline. Baste and press.

8. Finish hem suitably (see *Hem Finishes* under *How To Alter Hems* p. 9).

* For a skirt, follow the above procedure.

Faced Hem on a Straight Skirt

Cut a straight strip for facing long enough to equal measurement around bottom of skirt and proceed as for Faced Hem On A Flared Skirt.

* For a skirt follow the above procedure.

Other Suggestions For Lengthening a Dress

A Folded Band of Contrasting Color may be added to a dirndl type of skirt. The band when finished should be about 5" for a child and 7" for an adult. Strips of contrasting material cut either 11" or 15" wide allow for a double fold and a $\frac{1}{2}$ inch seam allowance.

A Concealed Piecing at Top of Skirt will serve to lengthen skirt. Conceal piecing with a contrasting peplum, and remake front of dress in contrasting fabric also, so that peplum will be part of dress and not obviously a cover up (Fig. A).

WAISTLINE

Waistline Too Low

1. Put on dress and mark correct waistline with pins. Baste around pin line.
2. Rip out placket and rip skirt from waist.
3. Mark center front and center back of skirt and waist.
4. Pin skirt to correct waistline marking, matching centers and side seams.
5. Baste, stitch skirt to waist, press, insert placket.

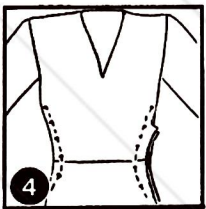

Dress Too Large at Waistline

1. Take out zipper and side seams. Press out folds. Refit both side seams by pinning in excess fullness evenly on sides (Fig. 4). Mark new seam lines on back and front with pins placed parallel to seam. Run basting along pin line. Place two basting lines together and sew right side seam. In same manner, sew left side

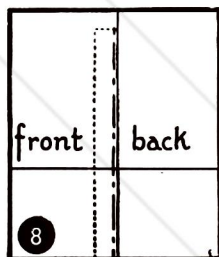
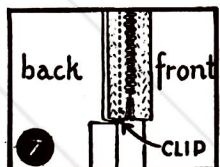
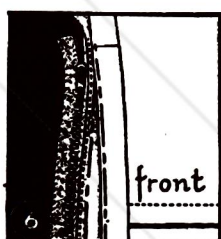
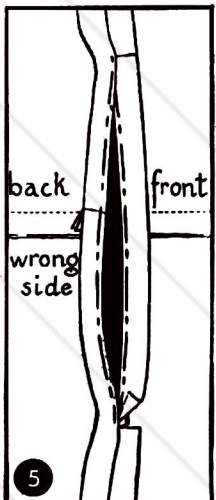

seam above and below placket opening (length of zipper teeth).

2. At front of placket opening, baste seam allowance back along marking line.

3. At back of placket opening, fold seam allowance $\frac{1}{8}$ " away from seam line. Continue fold $\frac{3}{4}$ " above and below opening (Fig. 5). Baste. Press both edges.

4. Pin and baste back edge of opening to zipper tape close to metal. Ease fabric to tape so that metal will lie flat. Stitch close to edge with cording foot. Extend stitching beyond opening to end of tape at both ends (Fig. 6).

At ends of tape, clip back seam allowance into seam (Fig. 7), so that it will lie flat. On right side, pin front edge of placket to seam line and baste firmly. Stitch front of placket to tape on right side using a cording foot. Make allowance for the extra width of the zipper slider and continue stitching at that width (Fig. 8).

* For a skirt follow the same procedure as above except that the belt is ripped off first, and applied again after zipper has been inserted. Excess length on belt is taken off at back of opening.

Note: Most difficulty in putting in zippers may be avoided by using a cording foot on the machine in place of the regular presser foot. This is a special foot which may be purchased at very small cost.

Bagginess at Back of Skirt of Dress

1. Take out back waistline seam and side seams of skirt. Press out folds.
 2. Raise back of skirt just enough to bring side seams into line ($\frac{1}{2}$ " to $\frac{3}{4}$ "). Refit side seams. Even hemline.
- * For a skirt, take off belt across back and follow the above procedure.

SLEEVES

Sleeves Out of Date

1. Take out sleeves and remake.
 - a. Take out sleeves, open up flat, press, and recut from desired pattern. Match "straight of goods" marking carefully to lengthwise thread of sleeves. Put in recut sleeves.
 - b. Proper sleeve *padding* is important. Cut a 6" square of fabric and fold diagonally. Pad to $\frac{1}{2}$ " thick at center fold, graduating to nothing at three points. Bind edges. Sew pad to shoulder seam, allowing fold edge to extend about $\frac{3}{4}$ " beyond armhole into top of sleeve.
2. Add contrasting yoke and sleeves, if sleeves and shoulders are too hopelessly out of date (Fig. B).

Sleeves Worn Out at the Elbow

Cut off sleeve just above worn place. Turn under desired length on one sleeve and pin. Try on to check for length and evenness (Fig. 9).

1. For a *plain hem*, baste around turned edge. Fold sleeve in half on seam, pinning this fold, and also pinning front and back of armhole seam together. Pin other sleeve the same way and match two sleeves to get correct line (Fig. 10). Baste. Press. Trim hems to 1". To fit sleeve to arm, take out excess in sleeve seam. Apply seam binding to edges and slip stitch (see p. 49).
2. For a *1" turn-up cuff* on a straight sleeve, mark desired finished line with a basting at fold (Fig. 11). Measure and mark around sleeve, 1" down from this line. Determine new line on other sleeve as above. Turn up on lower line, baste, press. Trim hem to $1\frac{1}{2}$ " and finish as before. Press cuff back on original marking line.

NECKLINE

Neckline Is Unbecoming

1. Take off old neckline finish. Press carefully. Run a machine stitch close to edge to prevent stretching. By pulling up this stitching slightly, a neckline which has been stretched may be eased in.
2. Select a pattern with desired neckline. Cut new line from this pattern, folding garment carefully at center front and center back before pinning on pattern. Apply suitable finish as suggested in pattern.

RESTYLING PROBLEMS

Dress Too Small

Insert contrasting panel in front. Choose a suitable pattern and re-cut dress and new panel from it (Fig. C).

Skirt of Dress Too Narrow

1. Take off old skirt at waistline, or cut off 3 to 5 inches below waistline, depending on style of dress. (If skirt is cut off below waistline, experiment with contrasting fabric to determine the most becoming line).
2. Add new skirt in contrasting fabric cut from a commercial pattern chosen to fit in with style of dress (Fig. D). Full gathered skirts accentuate size, as do bold contrasts. Subtle related colors, and dull, dark colors tend to decrease size.

Waist or Skirt of Dress Out of Date

Sometimes the skirt of a dress is entirely good and the waist is out of date or vice versa. Make the other half in contrast. This is especially good on evening dresses (Fig. E). Separate jackets and skirts are often possible. Bright striped jerkins can transform plain dresses (Fig. F).

SKIRT PROBLEMS

Most skirt problems can be handled in the same manner as dresses. In any section a * indicates special recommendations for skirts.

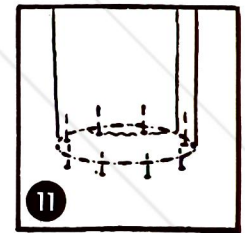
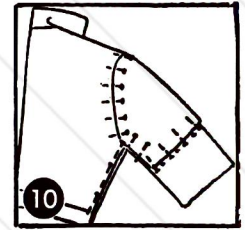
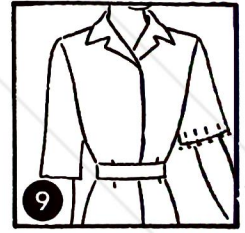

COAT PROBLEMS

How to Alter the Hem of a Coat

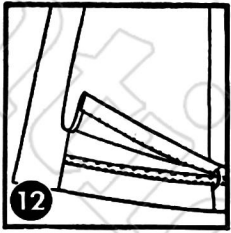

1. Rip lining from facing on inside of coat far enough to allow you to work comfortably. Free lining from hem of coat and take out both hems. Put on coat.

2. Determine new hemline in same manner as for dress (see p. 9). Mark new length on facing also.

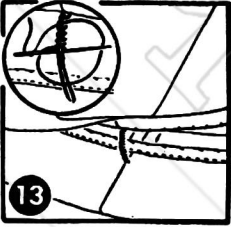

3. Turn up hem on coat and facing at new line by folding fabric at pin line and placing pins at right angles to fold (see p. 9). Baste close to fold. Press on wrong side.

4. Trim to $1\frac{1}{2}$ " using a gauge. Shrink out excess fullness (see p. 9, *Hem Finishes* 2). Finish raw edges by pinking, running a machine stitching close to edge, and catch stitching in place (see p. 49). Or machine stitch binding on hem edge and blind hem (Fig. 12).

5. To finish lining: Put coat on and pin lining to coat around bottom of coat about 4" above hem. Baste lining to coat around this line. Turn up hem of lining one inch shorter than hem of coat, using coat hem as a guide. Baste. Press. Blind hem lining separately, making a

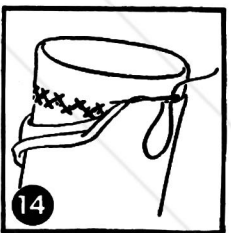

1" hem (Fig. 12). Fold facing back in place. On a coat which you do not expect to lengthen again, hem of facing is trimmed to $\frac{1}{4}$ " and slip stitched to lower edge of coat. (Do not trim facing on children's clothes.) Slip stitch lining to facing where it was ripped. Fasten lining to hem at each seam with French tacks (Fig. 13). French tacks are made like buttonhole loops (see p. 49).

How to Shorten Sleeve of Coat

1. Rip lining free from fabric at bottom of sleeves and take out any hems. Press out folds.

2. Adjust coat sleeves to desired length. Pin.

3. Try on to check evenness. Baste turning. Press.

4. Trim hem evenly, leaving not more than 2". Catch stitch in place (see p. 49).

5. Put coat on, adjust sleeve lining, and pin to lining at several points, about 3" from bottom of sleeve. Baste lining to sleeve at this point.

6. Turn up lining even with hem of sleeve, baste. Set lining edge $\frac{1}{2}$ " up from sleeve edge and slip stitch to sleeve (Fig. 14).

How to Line a Coat

Linings may be made of silk, rayon, or cotton, but a very durable fabric is rayon twill. For an average length of coat, buy, in 39" fabric, twice the length of garment plus about 12 inches for hems. Allow a little more or less according to width of fabric.

Cutting

1. Do not wait until lining is too badly worn since it is necessary to use it as a pattern.

2. Before ripping out, make a cross stitch to mark (a) where sleeve joins shoulder seam, (b) about midpoint on back and front of sleeve, (c) corresponding places on armhole, (d) where dart comes at front shoulder.

3. Rip lining out and press to use as pattern. Fold back in half on length, using this portion as a pattern. Use one side of front and one sleeve (one of each piece if there are two pieces). By using the old lining pieces as patterns, seam allowances and center back pleat are provided for. Be careful to cut opposite sleeves. This is best done by placing same sides of material together when cutting. When cutting, see that grain line is observed (see p. 48).

4. Cut fabric and make marks to correspond with old lining. Seam allowances are indicated by stitching lines on old lining.

5. Baste and stitch seams of sleeves and body of lining with the exception of the shoulder seams. Press open.

The Body of The Coat

6. Lay coat on table and put in lining wrong side to wrong side. Pin at underarm seams. Tack seam to seam from underarm to hip, using long stitches and working on wrong side.

7. Pin lining to front armhole seam (clipping, if necessary) and across front shoulder, pinning in dart as indicated. Ease lining up, so that it lies flat.

8. Pin lining to back armhole. Turn in seam allowance across back shoulder and baste. Pin fold edge over front. Baste around armhole and across shoulder.

9. At back neckline about one inch below seam allowance, pin from each side toward center back so that excess fullness becomes a pleat at center back. Ease lining up so that it lies flat. Turn in seam allowance. Pin and baste.

10. Turn in seam allowance on front. Pin and baste to front facings making sure that fabric lies flat and smooth.

11. Try on coat to make sure that lining does not draw. If it does, let out wherever necessary.

12. Catch stitch (see p. 49) front darts and back pleat for a few inches from the top. The back pleat is also caught at the waist.

13. Blind hem stitch (see p. 49) across shoulders. Begin 4" above hem on one side and blind hem stitch lining to front and neckline facings around to 4" from hem on other side.

14. Finish hem and lining by following directions on *How To Alter Hem of Coat* from step 2 on.

On coat of suit, the lining is attached at lower edge. Turn up lining even with hem. Trim to $\frac{1}{2}$ inch. Set lining edge $\frac{1}{2}$ " up from bottom edge, and slip stitch (see p. 49).

Sleeve

Put sleeve lining in coat sleeve wrong sides together and match marking on sleeves to markings at armholes. Turn under seam allowance between the two marked points at underarm. Pin over armhole and baste. Match marked point at top of sleeve to shoulder seam. Turn in seam allowance, pin over armhole, easing in fullness to fit. Blind hem stitch around entire armhole. Try on coat. Pin sleeve to lining at several points, 3" from bottom of sleeve. Baste lining to sleeve at this point. Turn up lining even with hem of sleeve, baste. Set lining edge $\frac{1}{2}$ " up from sleeve edge and slip stitch to sleeve (Fig. 14).

Variety is the Spice of Life



Clothes may make the woman but nowadays there's no doubt that accessories make the clothes. It's no trick at all for a dress to have nine lives. You can give last year's dress a new lease on life, make every costume pay extra dividends with a little needle and thread trickery.

At 9 a.m. a simple crepe dress looks trim and business-like with neat white collar and cuffs. At 9 p.m. the same dress, glamorized with a frothy dickey, a new belt, a gay little hat, may on occasion wear a fresh-as-paint party face.

Many a woman with a well-deserved reputation for chic has only a few basic costumes on which she has learned to ring endless changes. It's good fashion sense and smart dollars and cents to s-t-r-e-t-c-h your wardrobe with a versatile collection of easy-to-make accessories.

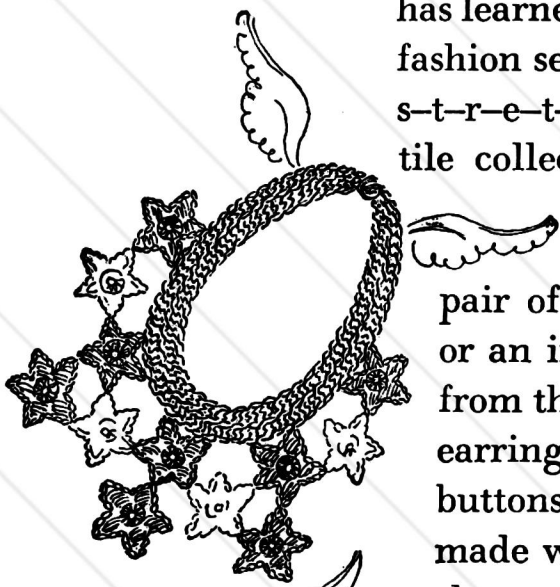

A polka-dotted hat and bag, a pair of red gloves and a matching calot or an inch of scarlet flounce peeping out from the bottom of a skirt; a necklace and earrings of bright crocheted stars; a set of buttons salvaged from a bureau drawer or made with a few bits of odd yarn change a dress so your best friend couldn't recognize it.

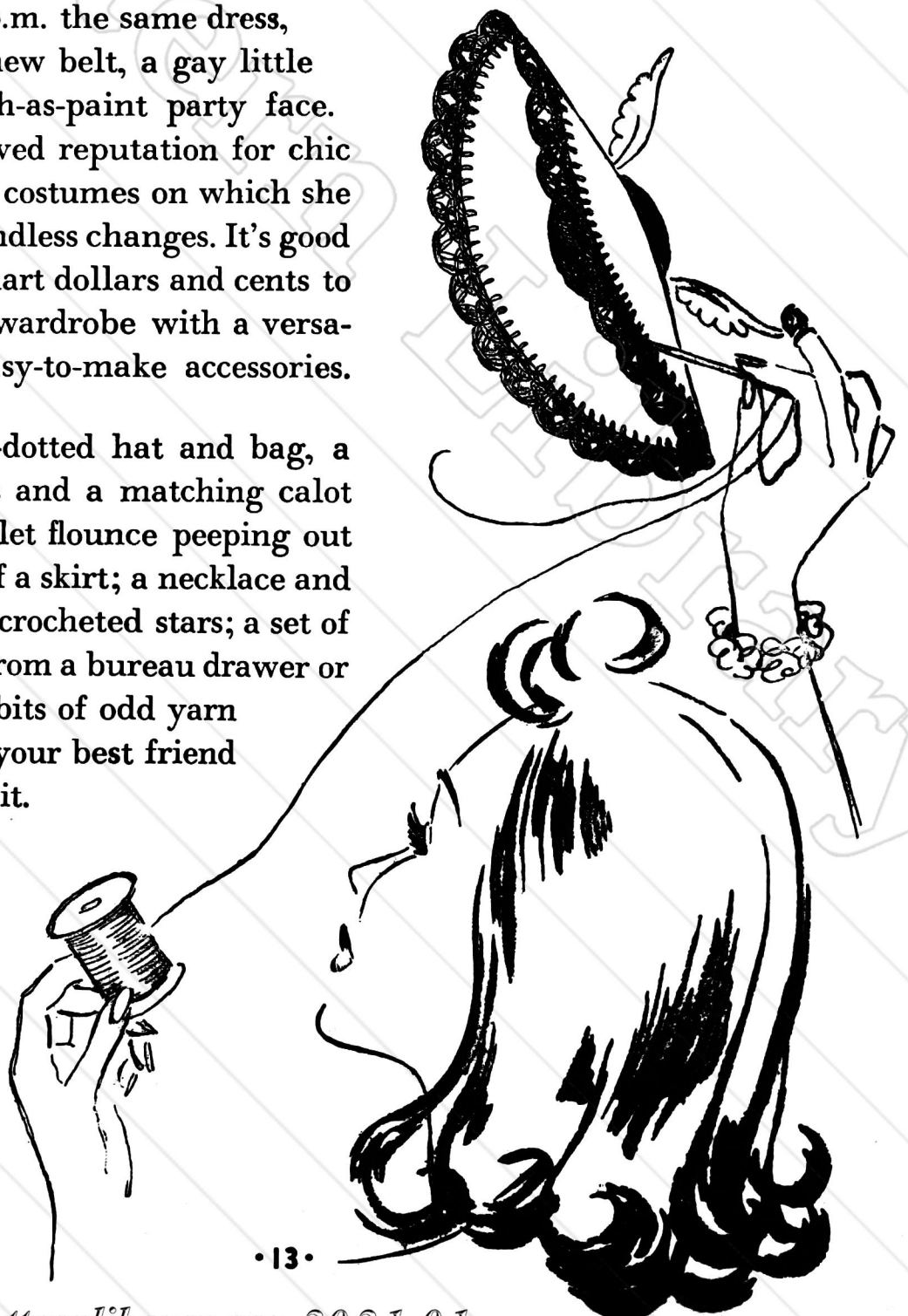

White Collar Class

**IT'S A FRAME UP
TO MAKE YOU PRETTIER**

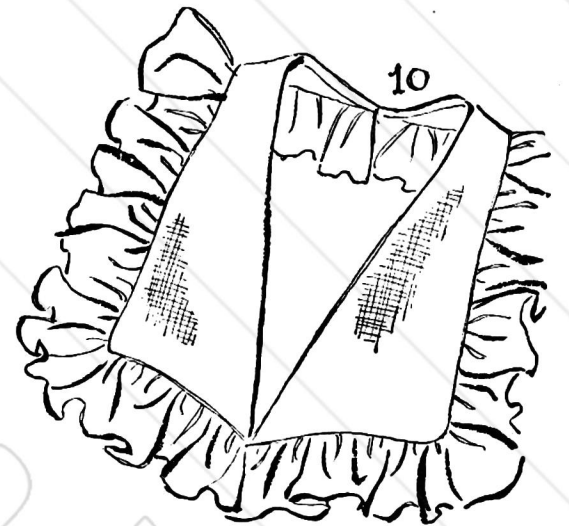

Left:

One Vestee with three jabots that button on. It's that easy to do a quick change.



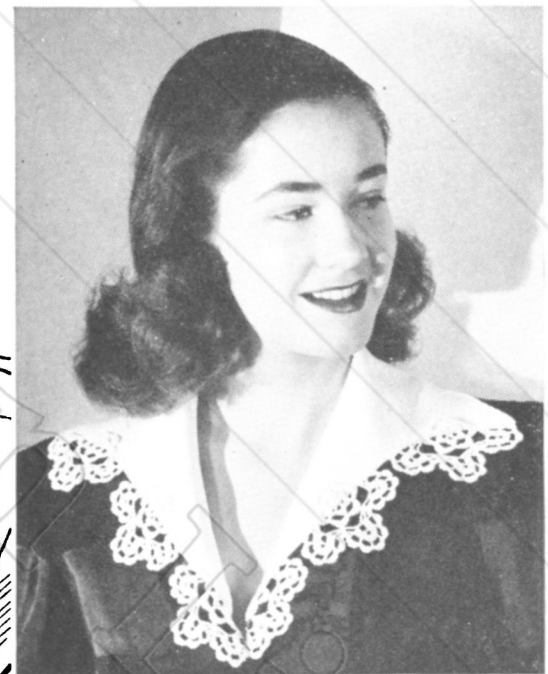
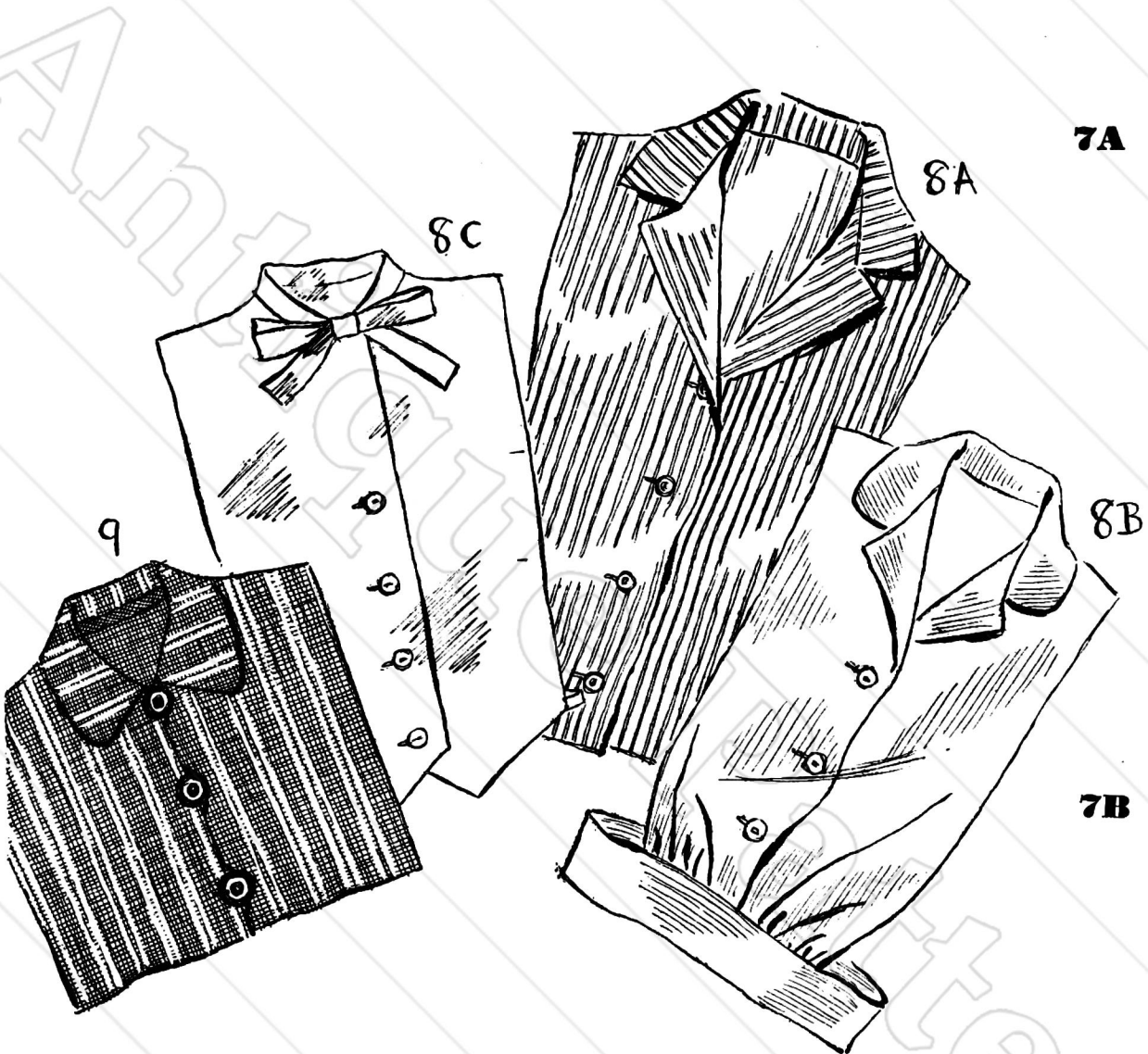

1. Pointed Collar. **2.** Square Collar. **3.** Vestee with Three Jabots: A. Band with Ruffle. B. Circle Jabot. C. Folded Circle Jabot. **4.** Scalloped Peter Pan Collar. **5.** Bias Band Collar with Ruffle. **6.** Button-On Collar with Crocheted Edging and Insertion No. 104. **7A.** V-Necked Collar with Frilly Crocheted Edging No. 100. **7B.** V-Necked Collar with Crocheted Medallion Trim No. 102. **7C.** V-Necked Notched Collar. **8A.** Regulation Elastic Bottom Dickey. **8B.** Band Bottom Dickey. **8C.** Vest Bottom Dickey. **9.** Short Dickey. **10.** Rever Collar with Ruffled Edging.



Edgings and Medallions of all kinds to trim any of the collars and dickeys. Below, 101 (top) and 103.

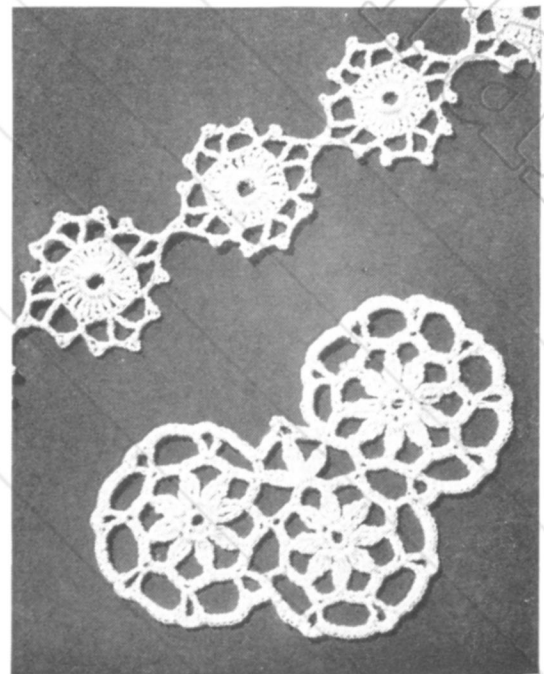

Directions for Making All Dickeys and Collars Begin on Next Page

White Collar Class

ILLUSTRATIONS ON PAGES 14 AND 15.

1. Pointed Collar

(Scraps of fabric)

1. Cut 2 Collar pieces from Pattern No. 1 on p. 23.
2. Stitch Collar pieces together around outer edge. Trim seams to $\frac{1}{4}$ ", turn, baste around turned edge. Press.
3. Finish neck edge with bias binding (see p. 49).

2. Square Collar

(Scraps of fabric)

1. Cut 2 Collar pieces from Pattern No. 2 on p. 23.
2. Stitch Collar pieces together around entire outer edge, leaving a 4" opening on neck edge to turn. Trim seams to $\frac{1}{4}$ ", turn Collar right side out through opening, baste around turned edge. Press.
3. Turn under $\frac{1}{4}$ " along each side of opening and slip stitch (see p. 49) edges together.

3. Vestee with 3 Jabots

($1\frac{1}{4}$ yds. fabric, 14" elastic, 8 pearl buttons, $\frac{1}{4}$ " diameter)

1. Cut Vestee from Pattern No. 3 on p. 23.
2. Stitch shoulder darts by bringing dotted lines together. Slash dart through center. Press open.
3. Finish entire outer edge and back opening of Vestee with narrow machine hem.
4. Finish neck edge with narrow bias binding of same fabric (see p. 49).
5. Sew 5 buttons at 2" intervals down center front.
6. Make thread loop (see p. 49) at top of right center edge of back opening and 2 more at 1" intervals. Sew buttons on left edge to correspond.
7. Sew elastic to sides of Vestee at waistline to hold Vestee in place.

A—Band with Ruffle . . . 1. Cut 2 Band pieces from Pattern No. 3-A and 1 Ruffle from Pattern No. 3-B both on p. 23.

2. Turn, baste, and press $\frac{1}{4}$ " all around both Band pieces. To turn around curved end easily, run a loose machine stitch around curve close to edge. Pull stitching up slightly and edge will turn under.

3. Roll hem (see p. 49) entire outer edge and ends of Ruffle.

4. Gather (see p. 48) inner edge of Ruffle to 18". Match center of Ruffle (on gathering line) to center of Band (at rounded end). Match end of Ruffle to end of Band. Top stitch (see p. 48) Band to Ruffle.

5. Place second Band piece over first on wrong side and slip stitch (see p. 49) into place.

6. Make worked buttonhole (see p. 49) to fit button on Vestee about $\frac{1}{4}$ " from straight end of Band. Make 3 more buttonholes so that tops of buttonholes are 2" apart.

B—Circle Jabot . . . 1. According to Fig. 1 cut Jabot.

2. Face two-inch tab at bottom of Jabot, taking $\frac{1}{4}$ " seams around edge.

3. Finish entire outer edge of Jabot, including two ties with narrow roll hem (see p. 49).

4. Make worked buttonhole (see p. 49) to fit button on Vestee, close to slash at center of circle. Make 4 more buttonholes so that tops of buttonholes are 2" apart (Fig. 1).

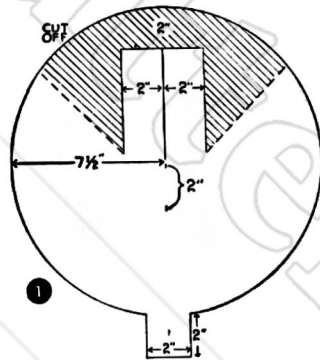

C—Folded Circle Jabot . . . 1. According to Fig. 2 cut Jabot.

2. Roll hem (see p. 49) all around.

3. Make worked buttonhole (see p. 49) to fit button on Vestee as indicated on pattern.

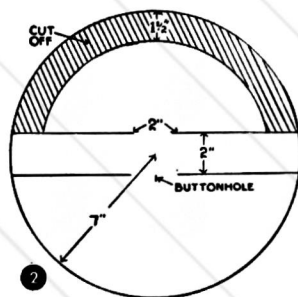

4. Scalloped Peter Pan Collar

(Scraps of linen and organdie)

1. Cut 2 Collar pieces of linen from Pattern No. 4 on p. 23. Mark scallops evenly around Collar $\frac{1}{2}$ " in from edge, using a circle the size of a quarter.

2. Follow step 2 under Pointed Collar No. 1 above.

3. Cut a bias strip (see p. 49) of organdie 2" wide. Fold in half lengthwise and overcast (see p. 48) to edge of Collar under scallops.

4. Finish neck edge with bias binding (see p. 49).

5. Bias Band Collar With Ruffle

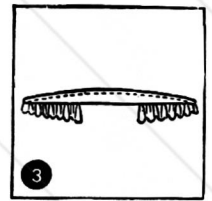

(Scraps of fabric)

1. Cut a bias strip (see p. 49) $3\frac{1}{2}$ " wide and 28" long. Fold in half lengthwise and trim ends as in Fig. 3. Cut two pieces for Ruffles each 30" long and 4" wide at one end, sloping to 3" wide at other end.

2. Roll hem (see p. 49) ends and straight edges of Ruffles.

3. Gather (see p. 48) raw edge to 10".

4. Starting at ends, stitch Ruffles to raw edge of folded bias strip, continuing stitching across center of strip (Fig. 3). Trim seam to $\frac{1}{4}$ ".

5. Finish entire edge with bias binding (see p. 49).

6. Button-On Collar With Crocheted Edging and Insertion—104

(Crochet Directions on p. 22.)

(Scraps of fabric)

1. Cut 4 Collar pieces from Pattern No. 6-A on p. 23. Cut from double fabric (right sides together). Cut 2 pieces from Pattern No. 6-B on p. 23.

2. Stitch two A pieces together around outer edges. Repeat with other two. Trim seam to $\frac{1}{4}$ ", turn, baste around turned edge. Press.

3. Roll hem (see p. 49) entire outer edge of both B pieces.

4. Whip (see p. 49) crocheted insertion to lower edge of A.

5. Whip opposite edge of insertion to circular edge of B.

6. Whip edging to outer and lower edge of B.

7. Finish neck edge and connect two collars with a 24" piece of bias binding (see p. 49).

8. Make 5 buttonholes (see p. 49) in bias band at center, ends, and in between. Attach buttons to garment.

7. A, B, C. V-Necked Collar ($\frac{1}{2}$ yd. fabric)

1. Cut 2 Collar pieces (either rounded or notched according to style desired) from Pattern No. 7 on p. 23.

2. Follow steps 2 and 3 under Square Collar No. 2 above.

8-A. Regulation Elastic Bottom Dickey

(1 yd. fabric, 4 buttons $\frac{1}{2}$ " size, 9" elastic)

1. Cut 2 Fronts, 1 Back, 2 Pointed

Collars, 2 Facings (Front as far as cut-off line) from No. 8 Patterns on p. 23.

2. Mark buttonholes ($\frac{5}{8}$ " long and 3" apart) as indicated, on outside of *right* Front by taking small stitches with colored thread.

3. Stitch Fronts to Back along shoulders.

4. Stitch Collar pieces together around outer edge. Trim seam to $\frac{1}{8}$ ", turn Collar, baste around turned edge. Press.

5. Stitch Collar to neck edge (under side of Collar to right side of Dickey).

6. Machine back stitch (see p. 48) inner (sloping) and shoulder edges of Facings.

7. Stitch Facings to center Front edges. Continue stitching Facing over Collar around neck edge to end of Facing.

8. Stitch bias binding (see p. 49) along seam across back of neck between Facings.

9. Trim neck edge and front seams to $\frac{1}{4}$ ". Turn Facing to inside, baste turned edges. Press.

10. Slip stitch (see p. 49) bias binding down across back of neck. Slip stitch Facing to shoulder seam.

11. Cut buttonholes through both thicknesses and finish with buttonhole stitch (see p. 49).

12. Sew buttons on left Front to correspond to buttonholes.

13. Finish sides of Dickey with narrow machine hem.

14. Make $\frac{1}{2}$ " machine hem along lower edges. Join Back and Front at sides by inserting $4\frac{1}{2}$ " pieces of elastic in hems.

8-B. Band Bottom Dickey

(1 yd. fabric, 7 buttons— $\frac{1}{2}$ " size)

1. Cut 2 Fronts and 1 Back (cutting off at waistline on dotted line as indicated), 2 Round Collars, 2 Facings (Front as far as cut-off line) from No. 8 Patterns on p. 23. Cut 2 Waistband pieces each 7" wide by 17" long.

2. Follow steps 2 through 13 under Regulation Dickey 8-A above.

3. Turn under and press $\frac{1}{2}$ " around all sides of Waistband pieces. Fold in half lengthwise and mark center. On Fronts, 2" in from sides, gather (see p. 48) 3" sections to 2" (Fig. 4). Insert Front and Back in each band, matching centers as shown. Baste all around band. Stitch (Fig. 4) through all thicknesses.

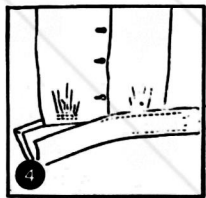

4. Make 2 buttonholes (see p. 49) on front ends of band and sew buttons on back.

8-C. Vest Bottom Dickey

(1 yd. fabric, 4 buttons— $\frac{1}{2}$ " size, 9" elastic, 1 snap)

1. Cut 2 Fronts (cutting off bottom in points as indicated), 1 Back, 2 Facings (Front as far as cut-off line) from No. 8 Patterns on p. 23. Cut a bias band 3" wide x 40" long for neck finish (see p. 49).

2. Follow steps 2, 3, and 6 under Regulation Dickey 8-A above.

3. Stitch Facings to center Front and lower pointed edges. Turn corner at neck edge and continue stitching Facing around neck for 1". Clip seam allowance at end of stitching.

4. Trim this seam to $\frac{1}{4}$ ", turn Facing to inside, baste turned edge. Press.

5. Fold bias band in half lengthwise (right side inside) and stitch across ends and down sides for 11". Clip in to seam at end of stitching. Trim seams to $\frac{1}{8}$ ", turn to right side and baste turned edges. Press.

6. Stitch one free edge of opening in band around neck edge (right sides together). Finished ends of band should come to edge of 1" finished section at center front of neck edge.

7. Turn in other edge of band $\frac{1}{2}$ " and slip stitch (see p. 49) to seam around inside of neck.

8. Follow steps 11 to 13 under Regulation Dickey 8-A above.

9. Join Back and Front at sides with $4\frac{1}{2}$ " pieces of elastic. Try on Dickey and if necessary take two small darts at waistline in Fronts for better fit.

9. Short Dickey

($\frac{1}{2}$ yd. fabric, 3 buttons— $\frac{1}{2}$ " size)

1. Cut 2 Fronts, 1 Back, 2 Facings (Front as far as cut-off line) and 2 Collars from No. 9 Patterns on p. 23.

2. Follow steps 3 to 10 under Regulation Dickey 8-A above.

3. Make thread loop (see p. 49) at top of *right* center edge and two more at 2" intervals below. Sew buttons on left center edge to correspond.

4. Finish entire outer edge of Dickey with narrow machine hem.

10. Rever Collar With Ruffled Edging

(Scraps of fabric)

1. Cut 4 Collar pieces from Pattern No. 10 on p. 23. Cut from double fabric (right side together). Cut 2 straight strips each 2" wide and 36" long for Ruffling.

2. Hand roll hem (see p. 49) ends and one side of each Ruffle. Gather (see p. 48) to 12".

3. Stitch a strip to outer edge of one *right* and one *left* rever. Place right sides together, edge to edge, leaving $\frac{1}{2}$ " at each end free of ruffling. Stitch on $\frac{1}{2}$ " gathering line.

4. Place right sides of other two Collar pieces against ruffling just stitched. Stitch together on previous stitching line. Turn. Baste turned edges flat. Press.

5. Finish neck edge with bias binding.

100—Frisly Edging

MATERIALS:

CLARK'S O.N.T. or J. & P. COATS MERCERIZED CROCHET, size 50, 2 balls. Steel crochet Hook No. 12.

Make a chain slightly longer than the measurement of the outside edge of collar. **1st row:** S c in 6th ch from hook, * ch 5, skip 1 ch, s c in next ch. Repeat from * across. Ch 5, turn. **2nd to 4th rows incl:** * S c in next loop, ch 5. Repeat from * across to within last loop, ch 3, tr in last loop. Ch 5, turn, but ch 7 to turn at end of 4th row. **5th row:** * S c in next loop, ch 7. Repeat from * across, ending with ch 4, tr in last loop. Ch 7, turn. Repeat the last row until piece measures 2 inches in all, adding 1 ch in each loop every other row. Fasten off. Starch lightly, press and whip (see p. 49) to outside edge of collar.

101—Motif Collar Edging

MATERIALS:

CLARK'S O.N.T. or J. & P. COATS MERCERIZED CROCHET, size 30, 1 ball. Steel crochet Hook No. 11.

1st MOTIF . . . Ch 9. Join with sl st to form ring. **1st rnd:** Ch 4 (to count as tr), 23 tr in ring. Join with sl st in 4th st of 1st ch made. **2nd rnd:** Ch 1, s c in same place as sl st, * ch 5, s c in 4th ch from hook, ch 1, skip 2 tr, tr in next tr, ch 5, s c in 4th ch from hook, ch 1, tr in same place as last tr, ch 5, s c in 4th ch from hook, ch 1, skip 2 tr, s c in next tr. Repeat from * around. Join with sl st in 1st s c made.

2nd MOTIF . . . Work as for 1st Motif until 1st rnd is complete. **2nd rnd:** Ch 1, s c in same place as sl st, ch 5, s c in 4th ch from hook, ch 1, skip 2 tr, tr in next tr, ch 3, drop loop from hook, insert hook in center p on a corner of 1st Motif, draw dropped loop through, ch 2, s c in 2nd st of last ch-3, ch 1, tr in same place as last tr. Complete rnd as on 2nd rnd of 1st Motif (no more joinings). Fasten off.

Continue thus joining motifs as 2nd was joined to 1st until piece is desired length. Fasten off.

Whip (see p. 49) to edge of collar.

(Cont'd on page 22)

12

**A BALL OF YARN
A SCRAP OF FELT
AND YOU . . .
LOOKING LIKE
A FASHION PHOTO**

Smart Headwork

13

- 12.** Fabric Covered Crino-line Sailor.
- 13.** Fabric Covered Crino-line Calot.
- 14.** Bow Calot with Back Ruffle and Matching Bag.
- 15.** Knotted Cap and Draw-string Bag.

17

15

14

16

• 18 •



16. Lacy Crochet Brimmed Sailor and Crochet Trimmed Collar. **17.** Triple Thread Snood. **18.** Popcorn Calot. **19.** Frill Pompadour Hat. **20.** Open Crown Double Crochet Calot. **21.** Closed Crown Single Crochet Calot. **22.** Crochet Trimmed Felt Hat. **23.** Made Over Visor Cap.

Directions For Making All Hats Begin On Next Page

22

21

20

23



Smart Headwork

ILLUSTRATIONS ON PAGES 18 AND 19.

11—Pillbox

(See photo on p. 32, No. 2)
(1 crinoline pillbox frame, $\frac{1}{4}$ yd. fabric, $\frac{3}{4}$ yd. $\frac{1}{2}$ " belting ribbon.)

Fig. 1—Mark center of length of crown, following grain of crinoline. Continue basting to outer edge.

Fig. 2—Measure length and width of crown, add 2". Cut rectangle of fabric to these dimensions, for top piece. Match center line of fabric to center line of hat. Pin.

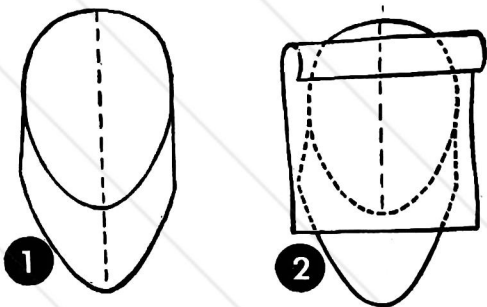

Fig. 3—Hold fabric taut and smooth. Pin around top edge. Baste and back stitch (see p. 48) to sides of crown, $\frac{1}{8}$ " below edge. Trim edge to $\frac{1}{4}$ ". At sides, measure around widest part of hat, add 3". For width measure deepest part of side, add 3". Cut true bias strip to these dimensions (see p. 49).

Fig. 4—Divide length of strip in half. Match and pin center to center front of frame with top edge 1" above crown edge. Stretch fabric to lie taut. Pin all around top and bottom of side. To finish back, turn under edge of one end on diagonal line.

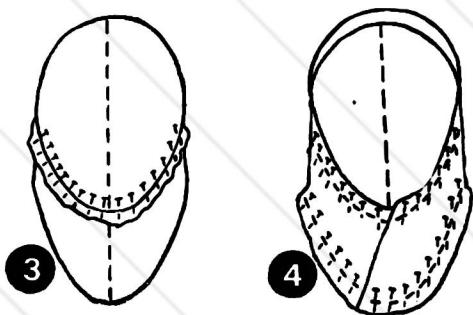

Fig. 5—Trim top and bottom edges to $\frac{1}{2}$ ". Turn under top raw edge. Slip stitch (see p. 49) to crown. Turn bottom edge to wrong side. Baste.

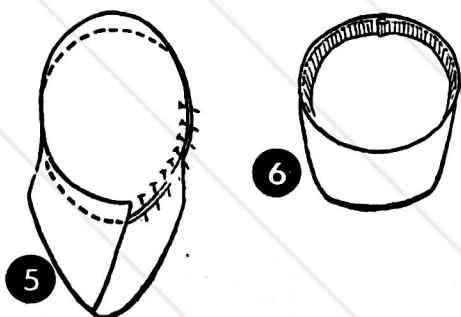

Fig. 6—*Making Sweatband*—Dampen belting. Shape with heated iron by stretching one edge with point of iron, all along length. Starting at center back inside of hat place stretched edge $\frac{1}{16}$ " from lower edge. Pin and baste all around. Overhand stitch (see p. 50). Turn under end $\frac{1}{4}$ " and catch to under piece of ribbon.

12—Sailor

(1 crinoline sailor frame, $\frac{1}{2}$ yd. fabric, $\frac{3}{4}$ yd. $\frac{1}{2}$ " belting ribbon.)
See Fig. 1 for marking frame.

Measure length of crown, add 3". Cut square of fabric to this dimension. Mark true bias (see p. 49).

Fig. 7—Match and pin bias line to center line of crown. Hold fabric taut and smooth. Pin around top edge. Baste and back stitch (see p. 48) to sides of crown, $\frac{1}{8}$ " below edge. Trim edge to $\frac{1}{4}$ ".

Fig. 8—Turn hat upside down. Measure length of hat brim. Add 4". Cut two squares of fabric to this dimension. Mark true bias on squares.

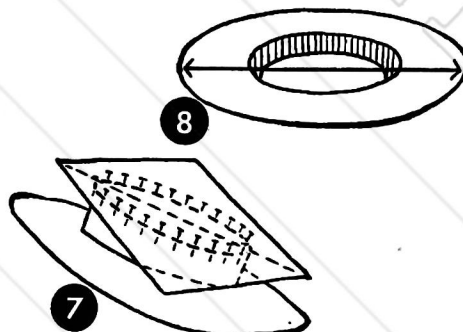

Fig. 9—On one square find center of bias line. On line, to each side of center measure off $\frac{1}{2}$ length of crown. Mark. From center point measure $\frac{1}{2}$ width of crown. Mark. Join points to make a circle. Cut around circle $\frac{1}{2}$ " to inside.

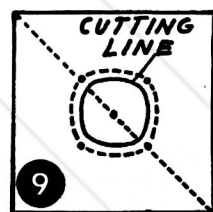
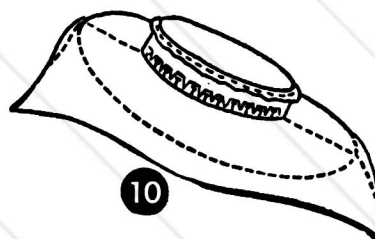

Fig. 10—Slip fabric over crown, right side up. Match bias line to guide line on brim. To fit fabric around crown, make small slashes all around circular edge. Hold fabric taut and smooth. Pin all around edge. Baste. Back stitch.

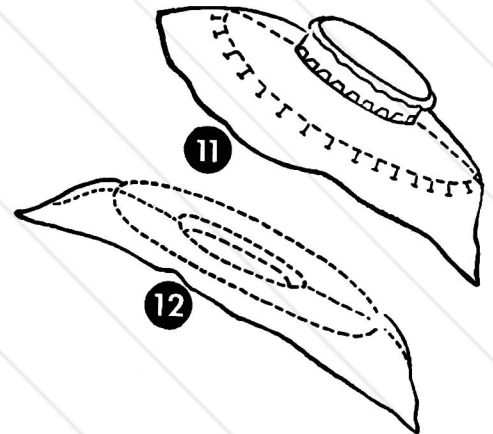

Fig. 11—At outer edge of brim gently stretch fabric taut and smooth. Pin $\frac{1}{4}$ " apart. Trim excess to $\frac{1}{4}$ ". Turn to underside of brim. Baste. Overhand stitch (see p. 49).

Fig. 12—Place square on underside of brim, right side out. Match guide lines. Fit outer edge as in Fig. 11. Slash fabric covering up crown. Fit to inside of crown and finish as in Fig. 10. Trim outer edge to $\frac{1}{4}$ ". Turn under so that finished edge is exactly on brim edge. Slip stitch (see p. 49).



Fig. 13—At sides measure around widest part of hat, add 3". For width measure deepest part of side, add 1". Cut true bias strip to these dimensions. Turn under one lengthwise edge $\frac{1}{2}$ ". Baste. Press. Match center of length to center front and place turned edge, right side out, over stitching line at bottom of crown. Blind tack at several points around. Finish back ends as in Fig. 4. Finish top edge as in Fig. 5. Apply sweatband as in Fig. 6. Trim as desired.

13—Calot

(1 crinoline calot frame, $\frac{1}{2}$ yd. fabric, $\frac{3}{4}$ yd. $\frac{1}{2}$ " belting ribbon, $\frac{1}{8}$ yd. crinoline.)

See Fig. 1 for marking frame.

Measurements for center strip: Take length of crown from back to front through center, add 2". Width is 4".

Cut on true bias (see p. 49). Mark lengthwise center with basting. On both lengthwise edges turn under $\frac{1}{4}$ ". Baste. Press.

Fig. 14—Match center line of fabric to center line of hat. Pin. Gently stretch and mold strip to fit shape. Pin at front and back edges. At sides on lower edge of calot divide distance of uncovered section in half. Mark.

Fig. 15—Cut a straight square of fabric 12" x 12". Divide in half on true bias line. Divide largest side of each triangle (bias edge) in half and mark. Match marking to marking on uncovered side, right side out. Allow 1" of fabric to extend over lower edge. Pin all around.

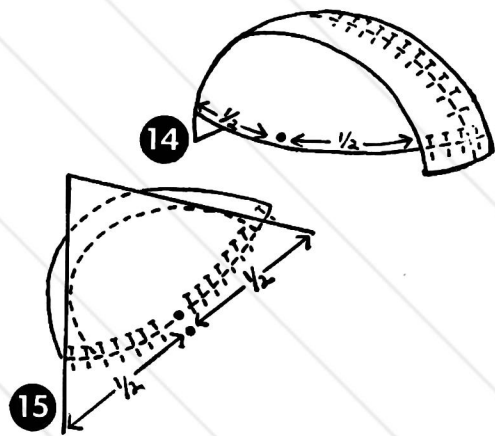
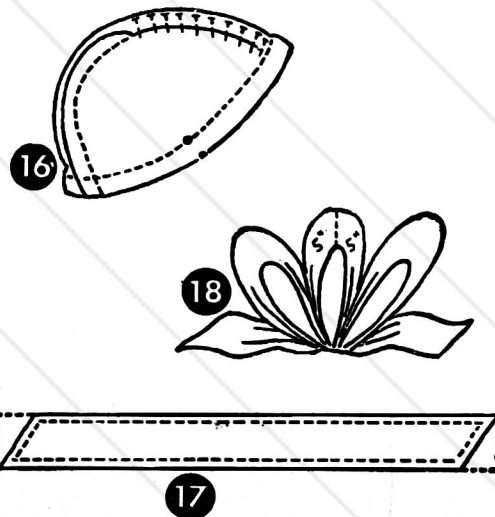

Fig. 16—Trim sides of triangle on a line with center bias strip, allowing $\frac{1}{2}$ " seam allowance. Slip side piece under center bias piece. Pin. Repeat on other side. Remove from shape. Baste. Top stitch (see p. 48) center piece to two sides. Fit covering on frame. Pin all around bottom edge as in Fig. 5. Trim excess to $\frac{1}{2}$ ". Turn to wrong side. Baste. Apply sweatband as in Fig. 6.

Fig. 17—For trimming cut two strips of fabric and one of crinoline each 39" long x 4" wide. Place two fabric strips right sides together. Place crinoline strip on top. Stitch ($\frac{1}{4}$ " seam) all three together, leaving a 4" opening along one side to turn, shaping ends as shown. Turn. On opening



turn under $\frac{1}{4}$ " and slip stitch (see p. 49). Press. Edge stitch.

Fig. 18—Mark center and measure 5" to each side. Mark. Bring 5" markings together and gather tightly through both thicknesses. Make a 10" loop on each side in same manner. Sew trimming in desired position.

13A—Similar Calot Made from Pattern

($\frac{1}{2}$ yd. fabric, $\frac{1}{2}$ yd. crinoline, $\frac{3}{4}$ yd. $\frac{1}{2}$ " belting ribbon.)

Cut 1 piece from Pattern No. 13A on p. 23.

Cut two pieces from Pattern No. 13B on p. 23. Cut same from crinoline. Cut A on bias, B on straight.

Fig. 19—With right sides together, place side piece to center piece with curved edge of side fitted to center piece. Stitch ($\frac{1}{4}$ " seam). Press open. Turn under $\frac{1}{4}$ " hem. Apply sweatband as in Fig. 7.



14—Bow Calot with Back Ruffle and Matching Bag

(1 yd. fabric, 3 skeins J. & P. Coats or Clark's O.N.T. Six Strand Embroidery Floss, $\frac{3}{4}$ yd. $\frac{1}{2}$ " ribbon belting, $\frac{1}{2}$ yd. heavy muslin, 3 bone hooks and eyes.)

Calot

1. Cut 10 pieces from Pattern No. 14 on p. 23. Cut a rectangle 12" x 22" for Ruffle, one 4" x 8 $\frac{1}{2}$ " for Band, and one 9" x 24" for Bow.

2. Make 2 calots of 5 sections each. Start at tip and stitch down each section. Press seams open. Place one calot inside the other, right sides together. Stitch around lower edge leaving 7 $\frac{1}{2}$ " open at center back to insert Ruffle. Turn through opening. Baste around turned edge. Press.

3. Fold Ruffle (12" x 22") piece in half to measure 6" x 22". Stitch 6" ends. Turn. Press. Gather (see p. 48) raw edges to 7 $\frac{1}{2}$ ". Baste and press.

4. Fold under $\frac{1}{2}$ " all around Band (4" x 8 $\frac{1}{2}$ ") piece. Top stitch one edge of Band to Ruffle. Press seam up. Slip stitch (see p. 49) other edge to seam line on wrong side. Slip stitch ends together.

5. Insert Band $\frac{1}{2}$ " in 7 $\frac{1}{2}$ " opening of Calot. Slip stitch Calot to Band.

6. Fold Bow (9" x 24") piece to measure 4 $\frac{1}{2}$ " x 24". Stitch one end and side. Turn, baste around turned edges. Turn in $\frac{1}{2}$ " at open end. Slip stitch together. Press.

7. Saddle stitch around edge of Bow (2 rows). Also saddle stitch 4 rows on Band, 2 rows around Ruffle, and along each side of each seam of Calot (see photo on p. 18).

8. Tack Bow piece together making 2 loops and 2 ends. Tack to center front of Calot.

Bag

1. Cutting edges on straight of goods, cut from heavy muslin: 2 rectangles 7 $\frac{1}{2}$ " x 14" for Bag; one rectangle 3" x 10" for Band; one rectangle 5 $\frac{1}{2}$ " x 10" for Flap. Using these as patterns cut two pieces of fabric from each piece of muslin.

2. Stitch 2 fabric pieces for Bag (7 $\frac{1}{2}$ " x 14") together along ends and one side. Turn. Do same with other two fabric pieces for Bag, and with muslin pieces for Bag. Place muslin Bag between two fabric Bags and baste all three together around open edge. Gather each side of top to 9".

3. Place 2 fabric Band pieces (3" x 10") right sides together. Place muslin Band piece on top. Stitch all three together along ends and one long side. Trim seam to $\frac{1}{4}$ ". Turn to right side. Baste around turned edges. Turn under $\frac{1}{2}$ " along both open edges of Band. Baste. Press.

4. Repeat step 3 above with Flap pieces (5 $\frac{1}{2}$ " x 10").

5. Insert one side of Bag between Band pieces. Slip stitch (see p. 49) edges to $\frac{1}{2}$ " gathering line on Bag.

6. Insert other side of Bag between Flap pieces in same manner.

7. Saddle stitch around Flap and Band (2 rows). (See photo on p. 18).

8. Whip (see p. 49) ends of Band to lower part of Flap where side edges meet.

9. Sew on fastenings.

15—Knotted Cap and Drawstring Bag

(1 $\frac{3}{4}$ yds. fabric, $\frac{1}{2}$ yd. heavy muslin, $\frac{3}{4}$ yd. $\frac{1}{2}$ " ribbon belting.)

Cap

1. Cut 2 pieces from Pattern No. 15 on p. 23, and two 5" circles.

2. Stitch two pieces together around edge, leaving 11 $\frac{1}{2}$ " side open. Turn.

3. Turn up a 4" hem around lower edge. Stitch by machine.

4. Turn lower edge up (on outside) to meet stitching line of hem. Tack in place. Turn up again (to outside) on this line. Tack.

5. Apply sweatband as in Fig. 6.

6. Gather tightly at bases of triangles.

(cont'd on page 22)

White Collar Class*(cont'd from page 17)***102—Collar Medallion****MATERIALS:**CLARK'S O.N.T. or J. & P. COATS MER-
GERIZED CROCHET. *size 30, 1 ball.**Steel crochet hook No. 10 or 11.*

MOTIF . . . Ch 6. Join with sl st to form ring. **1st rnd:** Ch 7 (to count as d c and ch 4) * d c in ring. ch 4. Repeat from * 4 more times. Join last ch-4 to 3rd st of 1st ch made. **2nd rnd:** In each ch-4 sp make s c, h d c, d c, ch 1, d c, h d c and s c. **3rd rnd:** Sl st across to next ch-1 sp, ch 1, s c in same sp. * ch 10. s c in next ch-1 sp. Repeat from * around joining last ch-10 with sl st to 1st s c. **4th rnd:** In each ch-10 sp make s c, 2 h d c, 3 d c, ch 1, 3 d c, 2 h d c and s c. Sl st in 1st s c. Turn. Hereafter work is done in rows. **5th row:** With wrong side facing sl st to next ch-1 sp, ch 1, s c in same sp. * ch 17. d c in 7th ch from hook, ch 3, skip 3 ch, d c in next ch, ch 6, s c in next ch-1 sp. Repeat from * 2 more times. Ch 1, turn. **6th row:** S c in 1st s c, * ch 5, d c in next d c, 3 d c in next sp, d c in next d c, 11 d c in next sp, d c in next d c, 3 d c in next sp, d c in next d c, ch 5, s c in next s c. Repeat from * 2 more times. Ch 1, turn. **7th row:** S c in 1st s c, * ch 3, d c in next d c, (ch 6, skip 3 d c, d c in next d c) 5 times, ch 3, s c in next s c. Repeat from * 2 more times. Ch 1, turn. **8th row:** S c in 1st s c, * ch 2, s c in next d c (in next sp make s c, h d c, 4 d c, h d c, s c, s c in next d c) 5 times; ch 2, s c in next s c. Repeat from * 2 more times. Fasten off. Make 5 more motifs same as this.

Blind stitch three medallions on each side of collar as shown in photograph 7B, p. 15.

103—Collar Medallion**MATERIALS:**CLARK'S O.N.T. or J. & P. COATS MER-
GERIZED CROCHET. *size 30, 1 ball.**Steel crochet hook No. 11.*

1st CENTER . . . Ch 6. Join with sl st to form ring. **1st rnd:** Ch 3, s c in ring. * ch 2, s c in ring. Repeat from * 5 more times. Join with sl st to 1st st of ch-3 first made. **2nd rnd:** Sl st in next ch-2 sp, ch 4, holding back last loop of each tr on hook make 2 tr in same sp, thread over and draw through all loops on hook (2 tr cluster), * ch 7, holding back last loop of each tr on hook make 3 tr in next sp, thread over and draw through all loops on hook (3 tr cluster). Repeat from * around ending with ch 7, sl st in top of 1st cluster. **3rd rnd:** * In next loop make 3 s c,

ch 2 and 3 s c. Repeat from * around. Fasten off.

2nd CENTER . . . Same as 1st Center.

3rd CENTER . . . Work as for 1st Center until 2nd rnd is complete. **3rd rnd:** In next loop make 3 s c, ch 2 and 3 s c, 3 s c in next loop, ch 1, sl st in any ch-2 loop of 1st Center, ch 1, 3 s c in same loop on 3rd Center. In each of next 5 loops make 3 s c, ch 2 and 3 s c, in next loop make 3 s c, ch 1, sl st in any ch-2 loop of 2nd Center, ch 1, 3 s c in same loop on 3rd Center. Sl st in 1st s c made. **Next rnd:** Sl st to next ch-2 loop, ch 4, in same loop make a 2 tr cluster, (ch 3, 3 tr cluster) twice. Sl st in next free ch-2 loop on 1st Center, (ch 7, in next ch-2 loop make tr, ch 4 and tr) 6 times, tr in next free ch-2 loop on middle Center, (ch 7, in next ch-2 loop make tr, ch 4 and tr) 3 times, ch 7, tr in next loop, in next free loop on 2nd Center make tr, ch 4 and tr, (ch 7, in next loop make tr, ch 4 and tr) 6 times, ch 7, sl st in top of joining 2 tr cluster. **Following rnd:** 4 sc in next loop, ch 5, s c in 5th ch from hook, 4 sc in next loop, * 8 sc in next ch-7 loop, 4 sc in next ch-4 loop. Repeat from * around. Join and fasten off.

Blind stitch three medallions on each side of collar.

104—Edging and Insertion**MATERIALS:**CLARK'S O.N.T. or J. & P. COATS MER-
GERIZED CROCHET. *size 50, 1 ball.**Steel crochet hook No. 12.*

EDGING . . . Make a chain the length desired. **1st row:** S c in 5th ch from hook, (ch 3, skip 1 ch, s c in next ch) 3 times; (4 loops made). * ch 6, skip 4 ch, s c in next ch, (ch 3, skip 1 ch, s c in next ch) 4 times. Repeat from * across, ending with 4 ch-3 loops. Ch 4, turn. **2nd row:** S c in next loop * (ch 3, s c in next loop) 3 times; ch 4, skip 2 ch of ch-6 loop, d c in next ch, ch 2, d c in next ch, ch 4, s c in ch-3 loop. Repeat from * across. Ch 4, turn. **3rd row:** S c in next loop, * ch 3 (s c in next loop) twice; ch 5, in next ch-2 sp make d c, ch 3 and d c; ch 5, s c in next ch-3 loop. Repeat from * across. Ch 4, turn. **4th row:** S c in next loop, * ch 2, s c in next loop, ch 6, d c in next d c, ch 2, in ch-3 sp make d c, ch 2 and d c; ch 2, d c in next d c, ch 6, s c in next ch-3 loop. Repeat from * across. Fasten off.

INSERTION . . . Starting at short end, ch 10. **1st row:** S c in 5th ch from hook, (ch 3, skip 1 ch, s c in next ch) twice. Ch 4, turn. **2nd row:** * S c in next loop, ch 3. Repeat from * across. Ch 4, turn.

Repeat the last row for length desired.

Smart Headwork*(cont'd from page 21)*

7. To make pompons, roll hem (see p. 49) around 5" circles. Make a running stitch close to edge, stuff with scraps, pull thread tight, fasten. Attach to ends of tails.

8. Tie tails in knot. Tack to shirring.

Bag

1. Cut a 7" circle of cardboard. Cut 8" circles of fabric and of lining. Turn under 1/2" around edges of both circles, place cardboard between, overhand (see p. 49) edges together.

2. Cut rectangle 16" x 26" from both fabric and muslin. Place both together and seam 16" ends (4 thicknesses) together. Make 2" hems at both ends of piece. Machine stitch. Run a row of machine stitching through center of one hem to make a casing. Open side seam between stitchings to insert tie.

3. To make tie, cut strip 32" x 2", fold in half, stitch 32" sides together. Turn. Insert in casing and trim ends with pompons made from 4" circles (see step 7 under Cap above).

4. Insert circle in bottom of bag and overhand (see p. 49) to side along line of hem. Turn up hem for cuff.

16—Lacy Crochet Brimmed Sailor and Crochet Trimmed Collar**MATERIALS FOR CROCHET:**CLARK'S O.N.T. or J. & P. COATS MER-
GERIZED CROCHET, *size 10, 8 balls of White.**Steel crochet hook No. 8 or 9.***HAT**

Starting at inner edge of Brim, make a chain 1/2 inch longer than the headsize of Crown. Join with sl st to form a ring being careful not to twist chain. **1st rnd:** Ch 3, 2 d c in sl st holding back on hook the last loop of each d c, thread over and draw through all loops on hook, ch 1 to fasten (a cluster made). * Skip 3 ch, 2 d c in next ch holding back the last loop of each d c on hook, thread over and draw through all loops on hook, ch 4, sl st in same place as last d c was made. Ch 4, 2 d c in 4th ch from hook holding back the last loop of each d c on hook and finish as for a cluster. Repeat from * around. Join. **2nd rnd:** Sl st in each ch and between 1st 2 clusters, s c in same place as last sl st, * ch 4 and make a cluster in 4th ch from hook, cluster between next 2 clusters, ch 4, s c between same 2 clusters. Repeat from * around. Join.

Repeat the last round until brim measures 2 1/2 inches wide. **Next rnd:** Sl st in each st to within 1st 2 clusters, s c between 2 clusters, * (ch 4,

(cont'd on page 24)

PATTERNS for DICKEYS, COLLARS and HATS

To make patterns actual size, transfer diagrams as shown to large paper marked with 1" squares. One small square = one 1" square.

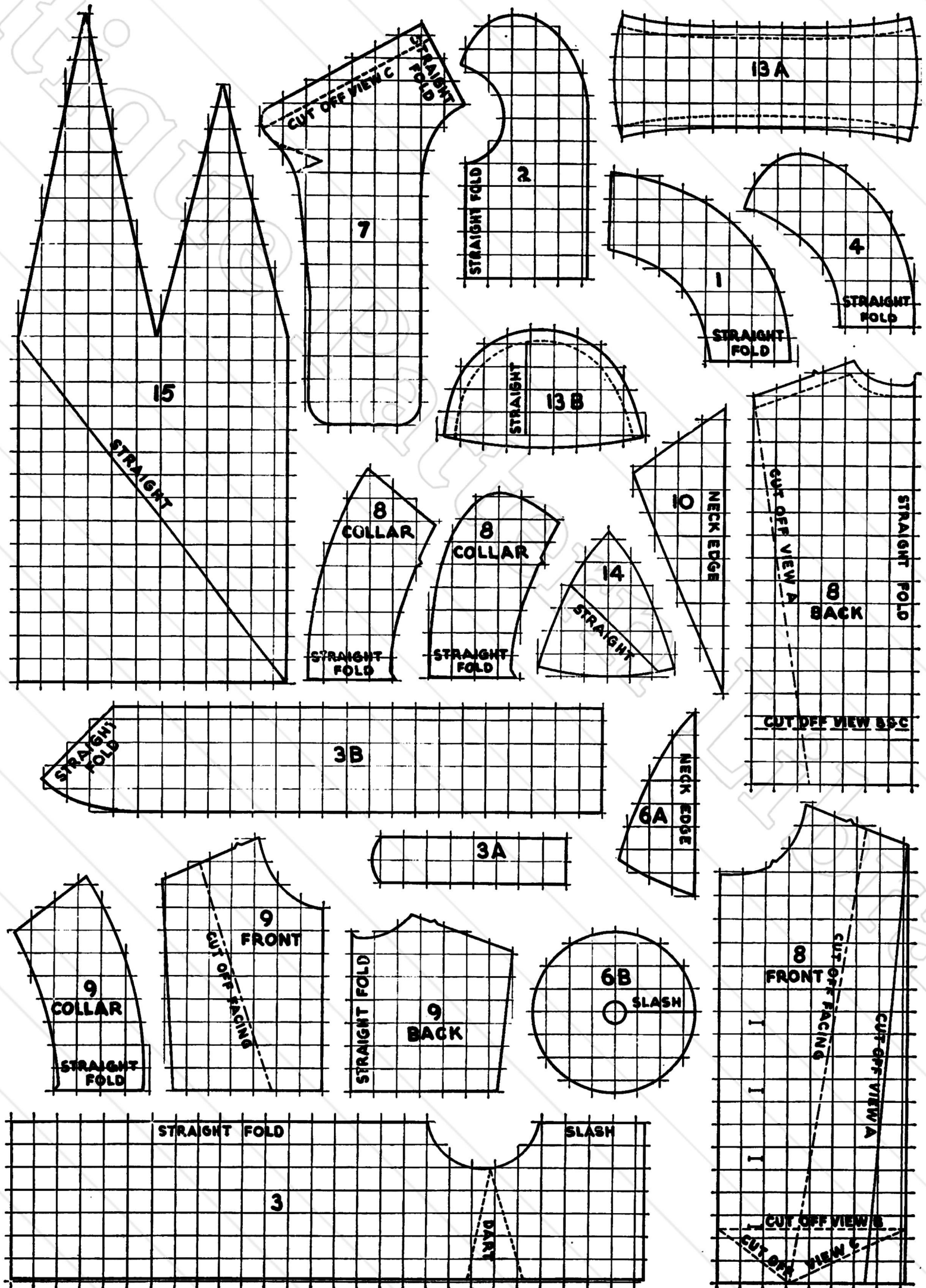

Crocheted Brim & Collar*(Cont'd from page 22)*

cluster in 4th ch from hook) twice; s c between next 2 clusters. Repeat from * around. Join and fasten off. Starch firmly, pull into shape and lay aside to dry thoroughly. For crown, buy crinoline sailor frame in desired shape, cut off brim, cover as on p. 20, No. 12. Turn inside edge of crocheted brim up $\frac{1}{2}$ " and blind hem to inside of crown. Cover a piece of millinery wire with grosgrain ribbon and stitch to wrong side of brim $\frac{1}{2}$ inch in from edge.

COLLAR EDGING

Make a chain slightly longer than the outer edge of collar, allowing for fullness at corner. **1st row:** * Make a cluster in 4th ch from hook, skip 3 ch, cluster in next ch, ch 4, s c in same place as last d c of cluster, ch 4. Repeat from * across, (ch 4, cluster in 4th ch from hook) twice; turn. **2nd row:** S c between 1st 2 clusters, * ch 4, cluster in 4th ch from hook, cluster at tip of next 2 clusters, ch 4, sl st between same 2 clusters. Repeat from * across, (ch 4, cluster in 4th ch from hook) twice; turn.

Repeat the last row until piece measures $2\frac{1}{4}$ inches. Turn as before. **Next row:** S c between 1st 2 clusters, * (Ch 4, cluster in 4th ch from hook) twice; s c between next 2 clusters. Repeat from * across. Join.

Starch if desired. Sew foundation chain to edge of V-necked collar No. 7 (directions on p. 16), placing fullness at corner.

17—Triple Thread Snood**MATERIALS:**

J. & P. COATS KNIT-CRO-SHEEN, 3 balls of any color.

Casein crochet hook No. 6.

11 inches of round elastic.

Use 3 strands throughout. Ch 51 to measure 12 inches. **1st row:** S c in 5th ch from hook, * ch 3, skip 2 ch, s c in next ch. Repeat from * across (16 loops). Ch 3, turn. **2nd row:** * S c in next loop, ch 3. Repeat from * across. Ch 4, turn. **3rd row:** * S c in next loop, ch 4. Repeat from * across. Ch 5, turn.

Continue in this manner, always making 1 ch more in each loop on each row until there are 9 ch in each loop. Work straight (ch-9 loops) for 13 rows. **Next row:** Work as for last row to within last loop, ending with an s c, ch 5, d tr in last loop. (1 loop decreased). Ch 9, turn. Repeat the last row until 6 loops remain. Fasten off.

Sew one end of elastic to each end of foundation chain securely. Attach a triple strand of thread and work a row of s c closely across foundation

chain keeping work flat, then working over elastic in order to conceal it make 2 s c in each loop around to where thread was attached. Join and fasten off.

FRILL . . . 1st row: Find center of foundation chain and mark with a pin. Measure off $3\frac{3}{4}$ inches on each side of pin and mark with pins. Remove center pin. Attach thread (3 strands) to loop at one pin mark and ch 5, * in first half of loop make tr, ch 1 and tr; ch 1, in second half of loop on other side of s c, make (tr, ch 1) twice and tr. Repeat from * across to pin mark at other side. Ch 5, turn. **2nd row:** * In next ch-1 sp make tr, ch 1 and tr; ch 1. Repeat from * across. Ch 1, turn. **3rd row:** 2 s c in each ch-1 sp across. Fasten off.

Sew each end of Frill to snood directly behind beginning and end of Frill keeping short sides flat.

18—Popcorn Calot**MATERIALS:**

J. & P. COATS KNIT-CRO-SHEEN, 2 balls of any color.

Steel Crochet Hook No. 2.

Use double thread throughout. Starting at tip of Crown, ch 6. Join with sl st to form a ring. **1st rnd:** Ch 3, 14 d c in ring. Join to 3rd ch of ch-3. **2nd rnd:** Ch 4, pc st in same place as sl st (to make a pc st ch 1, make 5 d c in same place as sl st, remove hook, insert it in ch preceding 5 d c and draw dropped loop through), * ch 1, pc st in next d c. Repeat from * around (15 pc sts). Join. **3rd rnd:** Ch 4, pc st in same place as sl st, * ch 2, pc st in next st. Repeat from * around, joining last ch-2 to top of starting ch-4 (15 pc sts). **4th rnd:** Sl st in next ch-2 sp, ch 3 and make a pc st in same sp, ch 2, pc st in same sp. * ch 2 in next ch-2 sp make pc st, ch 2 and pc st (an inc). Repeat from * around. Join. **5th rnd:** Sl st in ch-2 sp, ch 3, pc st in same ch-2 sp, * ch 2, pc st in next ch-2 sp. Repeat from * around.

Repeat the last rnd, increasing wherever necessary to keep work flat until piece measures $6\frac{1}{2}$ inches in diameter. Work without increasing until piece measures 6 inches from tip of Crown. Join and fasten off.

19—Frill Pompadour Hat**MATERIALS:**

J. & P. COATS KNIT-CRO-SHEEN, 1 ball of any color.

Casein Crochet Hook No. 6.

Divide the thread into 3 equal balls. Use a triple thread throughout. To begin ch 18 to measure 4 inches. **1st row:** S c in 6th ch from hook, (ch 2, skip 2 ch, s c in next ch) 4 times.

Ch 3, turn. **2nd to 11th rows incl:** * S c in next loop, ch 3. Repeat from * across. Ch 4, turn. **12th row:** (S c in next loop, ch 4) 4 times, turn (a loop decreased at end of row). **13th row:** (S c in next loop, ch 4) 3 times; turn (another loop decreased). **14th to 18th rows incl:** * S c in next loop, ch 4. Repeat from * across. Ch 4, turn. Do not turn at end of 18th row but work in rounds as follows.

FRILL . . . 1st rnd: (Ch 4, s c in same loop as last s c) twice; (ch 4, in next loop make s c, ch 4, s c, ch 4 and s c) 9 times; (ch 4, in next loop make s c, ch 4, s c, ch 4, s c, ch 4 and s c) 10 times; * ch 4, in next loop make s c, ch 4, s c, ch 4 and s c. Repeat from * to end of round, making 3 loops (instead of 2 loops) at lower corner. **2nd rnd:** (Ch 4, s c in next loop) 11 times; ch 4, s c in same loop as last s c—1 loop increased—(ch 4, s c in next loop, ch 4, in next loop make s c, ch 4, s c, ch 4 and s c) 29 times; * ch 4, s c in next loop. Repeat from * to end of rnd, ending with an s c. Fasten off. **Work is now done in rows instead of rnds.** **1st row:** Attach thread (3 strands) to 8th loop at beginning of previous rnd * ch 4, s c in next loop. Repeat from * to corresponding position on opposite side of Frill. Fasten off. **2nd row:** Attach thread (3 strands) to 15th loop at beginning of previous row, * ch 4, s c in next loop. Repeat from * to corresponding position at opposite side of Frill. Fasten off. **3rd row:** Attach thread (3 strands) to 10th loop at beginning of previous row, * ch 4, s c in next loop. Repeat from * to corresponding position at opposite side of Frill. Fasten off.

Weave in all loose ends and fasten them securely. If desired starch lightly or stiffen with millinery sizing.

20—Open Crown Double Crochet Calot**MATERIALS:**

J. & P. COATS KNIT-CRO-SHEEN, 1 ball of any color.

Steel crochet hook No. 7.

Starting at top make a chain $12\frac{1}{2}$ inches long ($8\frac{1}{2}$ ch sts to 1 inch). Join with sl st to 1st ch made, being careful not to twist chain. **1st rnd:** Ch 3, d c in next 7 ch, * 2 d c in next ch (1 d c increased), d c in next 8 ch. Repeat from * around. Join with sl st to 3rd ch of ch-3 first made. **2nd rnd:** Ch 3, d c in next 4 d c, * 2 d c in next d c, d c in next 8 d c. Repeat from * around. Join. **3rd rnd:** Ch 3, d c in each d c around. Join.

Repeat the last 2 rnds alternately, but do not have increases fall over those of previous increase round, until circumference of hat measures 20

inches. (If larger headsize is desired make a few more increases.) Work without increasing until piece measures $3\frac{3}{4}$ inches from starting chain. Join round and work a sl st in each d c around. Join and fasten off.

Place flowers over joining of rounds and sew securely in place.

21—Closed Crown Single Crochet Calot

MATERIALS:

J. & P. COATS KNIT-CRO-SHEEN, 2 balls of any color.

Steel Crochet Hook No. 7.

Starting at tip of Crown, ch 2. **1st rnd:** 8 s c in 2nd ch from hook. Do not join rnds. **2nd rnd:** 2 s c in each s c around. **3rd rnd:** * S c in next s c, 2 s c in next s c. Repeat from * around. **4th rnd:** S c in each s c around. Repeat the last rnd, increasing wherever necessary to keep work flat until piece measures $3\frac{1}{2}$ inches, now work as follows: **1st rnd:** S c in each s c around. **2nd rnd:** * S c in next 8 s c, 2 s c in next s c. Repeat from * around. **3rd rnd:** S c in each s c around. **4th rnd:** S c in next 4 s c, * 2 s c in next s c, s c in next 8 s c. Repeat from * around. **5th rnd:** S c in each s c around. **6th rnd:** Repeat 2nd round. Repeat the last 4 rounds until circumference measures 20 inches. (If a larger headsize is desired make a few more increase rnds.) Work without increasing until piece measures $5\frac{1}{2}$ inches from tip of Crown. Now sl st in each s c around. Join and fasten off.

FRILL . . . With single thread make a chain 13 inches long. **1st row:** Tr in 6th ch from hook, * ch 1, skip 1 ch, tr in next ch, ch 1, tr in same ch. Repeat from * across. Ch 5, turn. **2nd and 3rd rows:** Tr in next ch-1 sp, * ch 1, tr in next sp, ch 1, tr in same sp. Repeat from * across. Ch 5, turn. **4th and 5th rows:** Tr in 1st sp, * ch 1, tr in next sp. Repeat from * across. Ch 4, turn. **6th row:** * S c in next sp, ch 4. Repeat from * across. Fasten off. Starch Frill very stiff and press. Pleat Frill to measure 5 inches and sew to front of Calot, 1 inch up from edge. Extend ends of Frill as far as possible on either side and sew to Calot.

22—Crochet Trimmed Felt Hat

MATERIALS:

J. & P. COATS KNIT-CRO-SHEEN, 1 ball of any color.

A large brimmed felt hat, with very shallow crown.

Steel crochet hook No. 1.

Cut away crown of hat, leaving about $\frac{1}{2}$ inch on which to sew crocheted crown. Be very careful not to enlarge

head opening. Also, cut away any wire or other stiffening from outer edge of brim. Clean brim, if necessary, then lay flat on ironing board and press with hot iron through damp cloth. Allow to dry.

Note: Crochet is worked with double strand of thread throughout. Divide ball of thread into 2 parts.

CROCHETED CROWN . . . With double strand of thread, ch 5, join with sl st to form a ring. **1st rnd:** S c in ring, (ch 5, s c in loop) 5 times; ch 2, d c in 1st s c made (6 loops). **2nd and 3rd rnds:** S c in loop, (ch 5, s c in next loop) 5 times; ch 2, d c in 1st s c made. **4th rnd:** S c in loop, ch 4, d c in same place as last d c, * ch 4, s c in loop, ch 4, d c in s c. Repeat from * around ending with d c in last s c of previous rnd, tr in 1st s c of 4th rnd. **5th rnd:** Ch 3, work d c. ch 3 and d c in same place as joining tr, * ch 3, s c in d c, ch 3, in next s c work d c. ch 3 and d c. Repeat from * around ending with ch 1, d c in joining tr. **6th rnd:** Sl st in sp, s c in same sp, * ch 5, s c in next sp. Repeat from * around ending with ch 2, d c in 1st s c (18 loops). **7th rnd:** S c in loop, * ch 5, s c in next loop. Repeat from * around ending with ch 2, d c in 1st s c. **8th rnd:** S c in loop, ch 3, d c in same place as last d c, * ch 3, s c in next loop, ch 3, d c in s c. Repeat from * around ending with d c in 1st s c. **9th rnd:** Sl st in sp, ch 3, d c in next sp, * ch 3, tr in d c, ch 3, d c in next 2 sps. Repeat from * around ending with ch 3, sl st in top of starting ch-3. **10th rnd:** Sl st in d c, 3 ch and tr; ch 3, * tr in next 2 ch-3 sps, d c in next tr, ch 3, d c in next ch-3 sp, ch 1, d c in next ch-3 sp, ch 3, d c in next tr. Repeat from * around ending with ch 3, sl st in top of starting ch-3. **11th rnd:** Sl st in next st, s c between the 2 tr, * (ch 5, s c in next ch-3 sp) twice; ch 5, s c between next 2 tr. Repeat from * around ending with ch 2, d c in 1st s c. **12th rnd:** S c in loop, * ch 5, s c in next loop. Repeat from * around, ending as before.

Place felt brim on head, then try on crown and see if crown is deep enough to meet edge of felt. If not, repeat the 12th rnd to desired depth. Fasten off.

EDGING . . . Edging is worked directly around edge of felt brim. It is advisable to have a sharp sewing needle on hand to make holes in felt. Holes are made about every $\frac{1}{2}$ inch apart and about $\frac{1}{2}$ inch in from edge. Number of holes must be a multiple of 6. **1st rnd:** Attach double strand of thread to a hole at center back, work long s c in same place, * ch 3, long s c in next hole. Repeat from * around ending with ch 3, sl st in 1st s c. **2nd rnd:** S c in loop, * (d c, ch 2 and d c

in next loop) twice; s c in next loop. Repeat from * around ending with sl st in 1st s c. **3rd rnd:** Sl st in next d c, 2 ch, and next 2 d c; s c in same place as last sl st, * d c in next d c, ch 2, tr in s c, ch 2, d c in next d c, s c in next 2 d c. Repeat from * around ending with s c in d c, sl st in 1st s c. **4th rnd:** * Ch 2, in next sp work d c, ch 2 and d c; in next sp work d c, ch 2 and tr; in next sp work tr, ch 2 and d c; in next sp work d c, ch 2 and d c. Ch 2, s c between next 2 s c. Repeat from * around. Join and fasten off.

Block edging, pulling scallops into shape. Sew crocheted crown in place sewing crown over edge of felt brim.

23—Made-Over Visor Cap

MATERIALS:

CHADWICK'S RED HEART KNITTING WORSTED, 1 ball (1 oz. ball).

One old "Pork Pie" hat.

Steel crochet hook No. 1.

Brush hat and steam thoroughly over a boiling tea kettle. Remove trim and headband. Measure $2\frac{1}{2}$ inches for depth of Crown at front and mark with a pin. Measure 4 inches for depth of Crown at back and mark. Place pins around hat starting from pin mark at front and graduating pins to 4 inch depth at back. Cut along pin markings being careful not to cut into brim. Place a pin at center front of inner edge of brim just cut off. Measure off 5 inches on each side of center pin and mark. Place pins on a straight line from the marked points to outer edge of brim. Cut remainder of brim away leaving the 10 inches for peak at front. Curve the corners. Remove pins on Crown, excepting the center front pin. Place inner edge of peak inside Crown matching center front pins. Sew peak in place. With an embroidery stiletto or sharp pointed scissors pierce holes $\frac{1}{4}$ inch apart and $\frac{1}{4}$ inch in from edge, all along edge of peak and around edge of back of Crown being careful not to tear cap. With right side of cap facing attach yarn in any hole at back of cap. Work s c in each hole all around back of cap and peak. Join with sl st. Ch 1, turn. **Next rnd:** With wrong side facing work s c in same holes as last rnd. Join. Ch 1, turn. **Following rnd:** Work sl st in each s c of last rnd. Fasten off.

TIES (Make 2) . . . Ch 73. D c in 4th ch from hook and in each ch across. Fasten off. Fasten end of Ties where ends of peak join Crown. Tie in a bow at center front.

Telling Trifles

**IT'S THE LITTLE THINGS
IN LIFE THAT COUNT**

24. Pompon Trimmed Felt Pillbox. **25A to K.** Crocheted Button Trimmings. **26.** Bandanna Skirt and Two Piece Halter. **27.** Patchwork Skirt. **28.** Crocheted Belt and Frogs. **29.** Crocheted Frogs and Braid Trim. **30.** Crocheted Twisted Necklace and Earrings. **31.** Crocheted Star Necklace and Earring Set. **32.** Crocheted Wool Pocket. **33A and B.** Crocheted Wool Edgings.



24

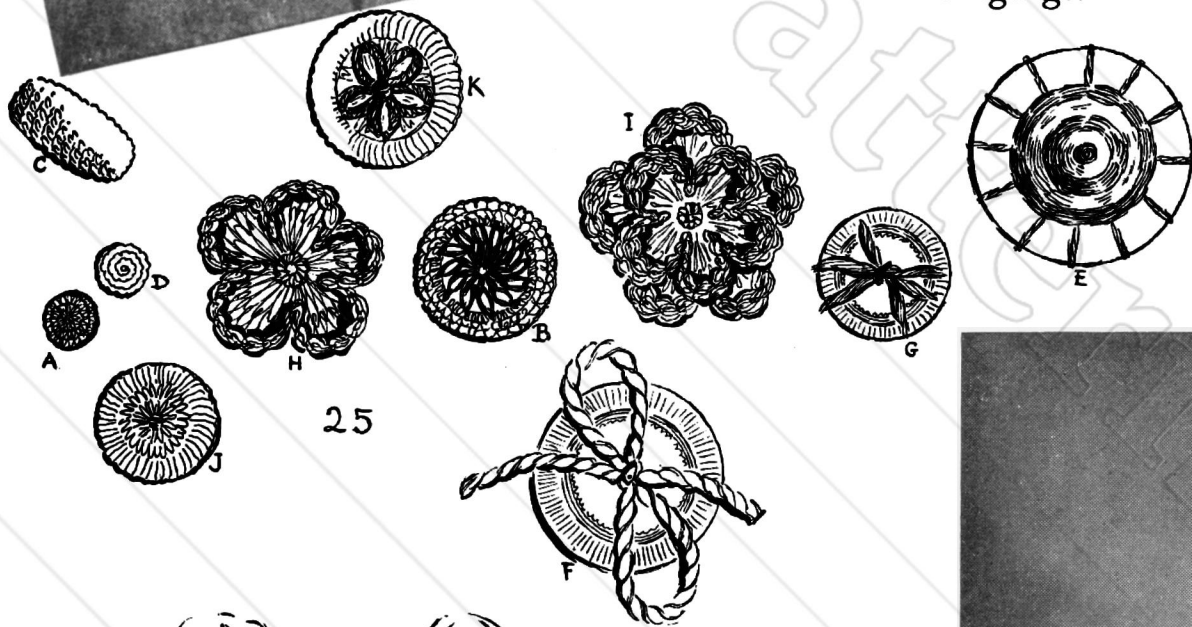

25

**Directions For Making all
Articles Mentioned Begin
On Next Page**



26

27



28

Learn how to crochet, see

33A

33B

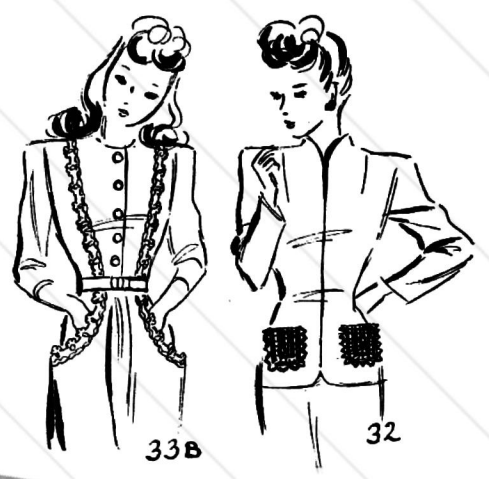
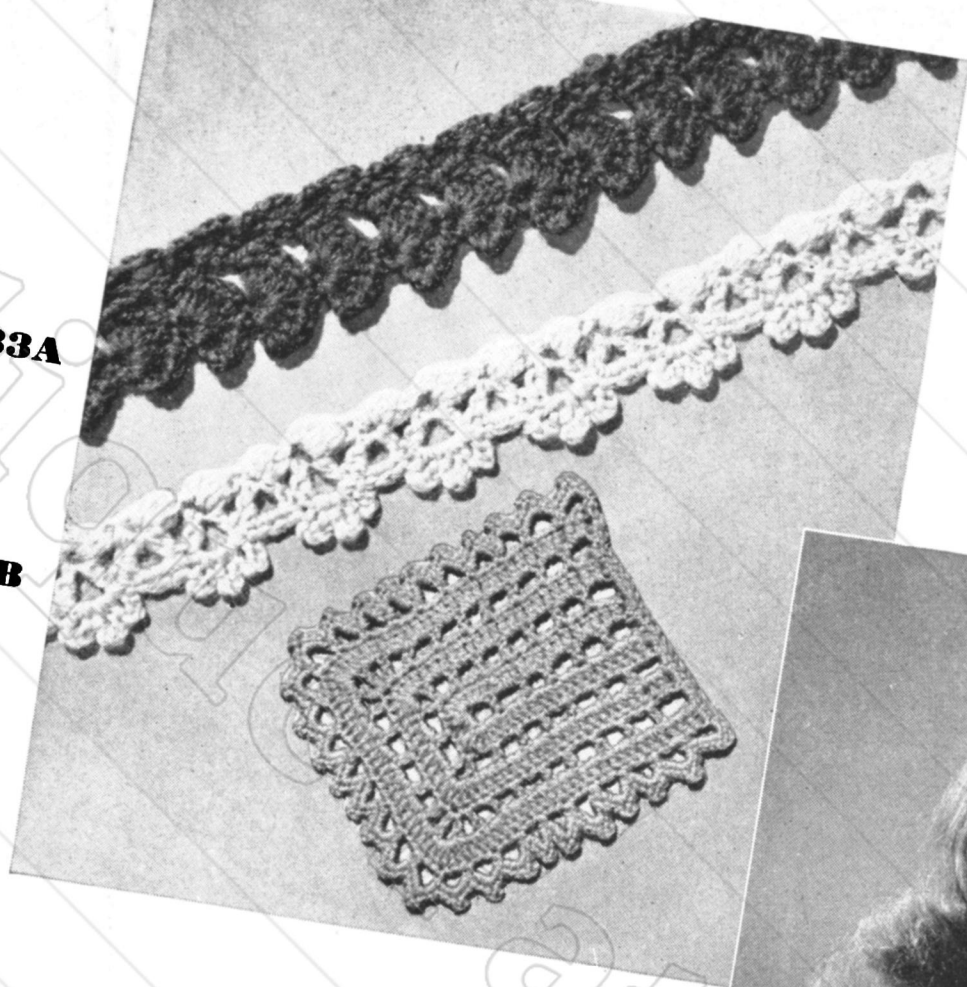

Crocheted Trimmings — frogs, bands, edgings, pockets — in wool or cotton — inexpensive ways to dress up old clothes and enliven new ones.

32



31



29



30

Necklaces and matching earrings of cotton crochet — non-priority jewelry that has plenty of priority on style.

Book 170, "Learn How"

Telling Trifles

ILLUSTRATIONS ON PAGES 26 AND 27.

24—Pompon Trimmed Felt Pillbox

MATERIALS:

CHADWICK'S RED HEART SWEATER
WOOL, 1 oz. ball.

One old felt pillbox hat.

Steel crochet hook No. 1.

Take all trimming off hat. Brush and steam hat thoroughly over a boiling kettle.

POMPON FLOWERS . . . Ch 2. 1st rnd: 9 s c in 2nd ch from hook. 2nd rnd: * Ch 10, s c in front loop of next s c. Repeat from * around. 3rd rnd: * Ch 10, s c in remaining back loop of next s c. Repeat from * around. Fasten off.

Cut a cardboard $1\frac{1}{2}$ inches wide and 3 inches long. Wind yarn 40 times around width of cardboard. Break yarn. Slip off cardboard. Wind yarn tightly around center of this bundle and tie. Cut loops of bundle and trim evenly. Pull tying strands through center of chain petals. Make 7 more Pompon Flowers same as this. Group 5 flowers on left side of hat and 3 flowers on right side of hat.

25—Crocheted Button Trimmings

A—Basic Crochet Button in Any Size . . . A variety of textures may be obtained by making the same button out of different materials: Knit-Cro-Sheen, Pearl Cotton or Shetland Floss. Buttons are worked over buttonmolds or old buttons as follows: 1st rnd: Ch 2, 6 s c in 2nd ch from hook. Do not join rnds. 2nd rnd: 2 s c in each st around. 3rd rnd: * 2 s c in next st. s c in next st. Repeat from * around (6 increases). 4th rnd: S c in each s c around increasing as necessary to keep work flat (about 6 increases on each rnd). Continue in this manner until piece is size of buttonmold or button which is to be covered. Work 2 rnds straight (no increases). Now decrease by working in every other st around (inserting button or buttonmold before opening gets too small) until all sts have been worked off. Fasten off.

B—2-Color Crochet Button in Any Size . . . Use Pearl Cotton. Work over buttonmolds or old buttons as follows: 1st rnd: With 1st color, ch 4, 11 d c in 4th ch from hook. Join with sl st to top of starting ch-4. Fasten off. 2nd rnd: Attach 2nd color in same place as sl st, ch 1, 2 s c in same

place, then work 2 s c in each d c around (24 s c). Do not join. Now follow directions for Basic Crochet Button—starting with 4th rnd.

C—Crocheted Barrel Button . . . Use Pearl Cotton or Mercerized Crochet Cotton. 1st and 2nd rnds: Same as 1st and 2nd rnds of Basic Crochet Button. This gives size of 1 end of button, if wider barrel is desired work 3rd rnd of Basic Button. Next rnd: Work s c in each s c around (no increases). Repeat the last rnd until button is length desired. Stuff firmly with absorbent cotton, or extra strands of thread, then decrease by working off 2 sts as 1 until no sts remain. Fasten off.

D—Crocheted Ball Buttons in Any Size . . . Use Pearl Cotton or Mercerized Crochet Cotton. 1st to 4th rnds incl: Same as 1st to 4th rnds incl of Basic Crochet Button. Repeat the 4th rnd until piece is size of button desired. Work 2 rnds straight (no increases) then decrease by working in every other st around until only very small opening remains. Stuff very firmly with absorbent cotton, or extra strands of thread, then continue decreasing until no sts remain. Fasten off.

E—Rainbow Button . . . Made with Mexicana yarn over a $1\frac{1}{2}$ inch buttonmold as follows: Cut a complete color sequence of yarn, starting with Purple and ending with Blue. Thread into a sewing needle and make a knot at the Purple end. Work through hole in center of buttonmold and around outer edges, make 9 stitches (or spokes) evenly spaced around. Fasten on wrong side and bring yarn through to top. Now weave over and under the spokes from center out until yarn is all used up. Fasten off.

F and G. Any plain 2-hole button can be made very decorative by sewing on with odd scraps of yarn. F is sewed on with a strand of Knitting Worsted, which is made into a bow. G is sewed on with scraps of 3 different colors of Shetland Floss which are knotted together at center and then cut, leaving 6 ends.

H and I—Crocheted Flower Buttons . . . Use Knit-Cro-Sheen. Work over flat pearl button for base as follows: **H—Single Flower Button:** 1st and 2nd rnds: Same as 1st and 2nd rnds of Basic Crochet Button. 3rd rnd:

Work in front loop only of each st around as follows: * In next st work half d c, d c, 3 tr, d c and half d c; s c in next st. Repeat from * around (6 petals). 4th rnd: Working in back of petals, work 2 s c in back loop only of each st of 2nd rnd. 5th rnd: S c in each s c around. Now decrease by working in every other st around (inserting flat pearl button before opening gets too small) until all sts are worked off. Fasten off.

I—Double Flower Button: 1st to 4th rnds incl: Same as 1st to 4th rnds incl of Single Flower Button. 5th rnd: Work in front loop only of each st around as follows: S c in next 2 sts, * in next st work half d c, d c, 3 tr, d c and half d c as before; s c in next 3 sts. Repeat from * around. 6th rnd: Working in back of petals, work s c in back loop only of each st of 4th rnd. Now decrease by working in every other st around (inserting flat pearl button before hole gets too small) until all sts are worked off. Fasten off.

J and K—Bone Ring Buttons . . . Use Shetland Floss. Work over bone rings in size desired as follows: With crochet hook work half d c closely all around ring. Break yarn, leaving a 12 inch end. Thread this end into a sewing needle and run through outer edge of each st around. Draw yarn tight thus turning sts in toward center of ring. Fasten securely, closing hole entirely. This completes J. K is embroidered, with a flower in lazy daisy st in contrasting color.

26—Bandanna Skirt and Two-Piece Halter

SKIRT . . . Measure skirt length, waist to hem. Bandanna handkerchiefs come in several sizes, 27" x 27", 24" x 24", and 24" (wide) x 22" (long). Buy the size according to skirt length.

Materials: 5 bandannas, snap fasteners.

Stitch selvage edges (length) of 4 bandannas together. Leave one seam open 7" for side opening. Press seams open. Turn under and hem down $\frac{1}{2}$ " at front of opening. Run two rows of loose machine stitching around top edge, $\frac{1}{2}$ " and $\frac{1}{4}$ " from edge. From other bandanna, cut 2 strips each 4" wide for Skirt Belt. Join one end of each piece to make long belt. Measure waistline and divide measure-

ment into 4 equal parts. Measure these distances off on belt using seam as center and mark with bastings (Fig. 1). Fold belt in half lengthwise, right side inside, and stitch up ends to first markings. These are for ties. Turn ends. Press. Pull up skirt gathers. Placing right side of skirt against right side of belt, match seams on skirt to markings on belt (ends of belt at opening). Adjust gathers to fit, distribute evenly, pin, baste. Stitch on $\frac{1}{2}$ " gathering line. Press band up. Turn under $\frac{1}{2}$ " on inner edge of belt and slip stitch to seam. Sew several snaps along 7" side opening.



TWO-PIECE HALTER . . . Materials: 1 square bandanna (27" size is preferable but 24" will do for size 12), 2 buttons. (Straps are cut from extra bandanna from which skirt belt was cut.)

Draw a line from corner to corner of bandanna and cut in half diagonally. Hem cut edge with narrow machine hem of about $\frac{1}{4}$ ". Cut 2 strap pieces each 5" wide from bandanna used for skirt belt. Fold strap pieces right side inside and stitch lengthwise edges together. Turn. Press. Make sure pattern on band is centered as it is pressed. Seam will therefore be at center of wrong side. Stitch corner of each triangle to strap (see illustration). Tie triangles around body (Fig. 2). Cross straps at back and pin in comfortable position. Sew buttons to halter on these points and make worked buttonholes (see p. 49) in corresponding position on straps. Cut off strap ends $1\frac{1}{2}$ " beyond buttonhole, turn in ends $\frac{1}{2}$ ", and slip stitch edges together. Fit out excess fullness at side front over bust by taking small darts.



27—Patchwork Skirt

($\frac{3}{4}$ yd. each of 5 different cotton prints or enough large pieces from the scrap bag.)

The finished skirt is 25" in length from belt to hemline. There is a 3" allowance for seams and hem. Alter length at hemline. Take a piece of paper you can use as a pattern. Cut

it to measure 28" x 30". On sides of paper measure off various distances as shown in (Fig. 3). Join points and mark numbers as illustrated. Cut paper along dotted line. Save one half for a guide. Cut out each shape of other half carefully following ruled lines. Cut six pieces of material from each shape, marking number of piece on back. Join one piece of each number, following half diagram which was not cut apart. Join pieces together along correct sides. Join shapes to make 5 more sections like this. Match 2 sections together joining on dotted line (Fig. 3), making a large piece about 28" x 30". Make 2 more pieces the same. Stitch the 3 together on their length. Leave one seam open 7" from top for side opening. Back stitch $\frac{1}{2}$ " at bottom edge of skirt. Turn up a 2" hem and finish by hand.

For belt, cut 2 strips of any color used, 4" wide and 27" long. Finish side opening and belt as described in Bandanna Skirt No. 26 above.

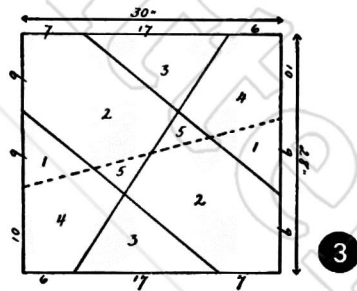

28—Belt and Frogs

MATERIALS:

CLARK'S O.N.T. or J. & P. COATS PEARL COTTON, size 5, 9 balls of any color.

Steel crochet hook No. 2/0 (double zero).

5 buttons, $\frac{5}{8}$ inch in diameter.

This material is sufficient for a belt and 3 complete frogs.

BELT . . . With triple thread, ch 14. Join with sl st to form ring. Make 20 s c in ring. * Ch 20, turn. Sl st in 14th ch from hook. Turn. Make 6 s c in ring, drop loop from hook, insert hook in 6th s c on last ring and pull loop through thus joining rings, 14 s c in chain-ring. Repeat from * until piece measures desired waist measurement. Ch 14, turn, sl st in 14th ch from hook, turn. Make 20 s c in chain-ring (this is button loop). Ch 14, turn, sl st in 14th ch from hook. Make 20 s c in chain-ring. Sl st in base of 3 rings. * Make 5 s c in the chain joining rings, sl st in base of next ring, ch 14, turn. Sl st in 14th ch from hook. Make 20 s c in chain-ring. Repeat from * across. Fasten off.

If desired, belt can be faced with grosgrain ribbon or dress material.

FROGS . . . With triple thread ch 14. Join with sl st to form ring. Make 20 s c in ring. * Ch 14, turn, sl st in 14th ch from hook, turn. Make 20 s c in ring, sl st in base of ring. Repeat from * once more. Fasten off. Make another piece same as this but do not fasten off. Ch 20, turn. Sl st in 20th ch from hook, turn. Make 30 s c in ring, sl st in base of rings. Fasten off.

BUTTON: With triple thread ch 2. 1st rnd: 6 s c in 2nd ch from hook. Do not join rnds. 2nd rnd: 2 s c in each st around (12 sts). 3rd rnd: S c in each st around. Place button inside this piece. * Work off 2 sts as 1 st, s c in next st. Repeat from * until opening is entirely closed. Fasten off. Make another button same as this. Sew a button at base of rings on each piece.

29—Crocheted Frogs and Braid Trim

MATERIALS:

CLARK'S O.N.T. or J. & P. COATS PEARL COTTON, size 5, 4 balls of any color.

Steel Crochet Hook No. 1.

14 bone rings $\frac{5}{8}$ inch in diameter.

BRAID: With double thread ch 6, s c in 3rd ch from hook (p made), ch 3, d c in 1st chain made (starting ch). Ch 3, turn. 2nd row: S c in top of d c (p), ch 3, d c in s c of p of row below. Ch 3, turn. Repeat 2nd row for length desired. Fasten off.

BACK BELT: With double thread, ch 6, s c in 3rd ch from hook (p made), ch 3, d c in 1st chain made. Ch 6, turn. 2nd row: S c in 3rd ch from hook (p), ch 3, d c in d c, ch 3, d c in s c of p of row below. Ch 3, turn. 3rd row: S c in d c (p), ch 3, d c in d c, ch 3, d c in s c of p of row below. Ch 3, turn. Repeat 3rd row until piece is $5\frac{1}{2}$ inches. Fasten off.

RING MEDALLIONS: With double thread work 32 s c over a bone ring. Join with sl st to 1st s c made. 1st rnd: Ch 7, s c in 3rd ch from hook, ch 1, d c in same place as sl st, * ch 1, skip 3 s c, d c in next s c, ch 4, s c in 3rd ch from hook, ch 1, d c in same place as last d c. Repeat from * ending with ch 1, sl st in 3rd st of 1st ch made. Fasten off. Fasten a Ring Medallion to each end of Back Belt.

FROGS: With double thread ch 13. 1st row: D c in 4th ch from hook, * ch 1, skip 1 ch, holding back last 2

(cont'd on page 30)

TELLING TRIFLES (continued)

Crocheted Frogs and

Braid Trim (cont'd from page 29)

loops of each d c on hook make 2 d c in next ch. thread over and draw through all loops on hook (cluster). Ch 7, turn. **2nd row:** S c in 3rd ch from hook, ch 1, d c in base of turning ch, * d c in top of next cluster, ch 4, s c in 3rd ch from hook, ch 1, d c in same cluster. Repeat from * to end of piece; then work along opposite side of clusters in same way. Join to 3rd st of turning ch. **3rd row:** Ch 7, s c in 3rd ch from hook, * d c between 2 d c, ch 4, s c in 3rd ch from hook. Repeat from * around. Join. Fasten off.

RING TRIM: S c closely over ring. Join to 1st s c made, make a 2-inch chain; then cover another ring. Join and fasten off. Sew a set of rings on Frog, draping chain between rings.

TIES: Ch 1, pull loop on hook out 1 inch (thread over, insert hook in same ch-1 and pull loop out 1 inch) 4 times; thread over and draw through all loops on hook, ch 1 to fasten. Continue making chain until Tie measures 7 inches. Fasten off. Attach Tie to end of Frog. Make 5 more Frogs same as this.

30—Twisted Necklace and Earrings

MATERIALS:

CLARK'S O.N.T. or J. & P. COATS PEARL COTTON, size 5, one ball each of Blue and Yellow, or any other colors.

Steel Crochet Hook No. 5.

2 earring bases.

NECKLACE . . . With Yellow make a chain 13 inches long (about 8 ch sts to 1 inch). **1st row:** S c in 2nd ch from hook and in each ch across. Ch 1, turn. **2nd row:** Work in the back loop only of each st. * In next st make s c, h d c, d c and tr, in next st make tr, d c, h d c and s c. Repeat from * across. Fasten off. **3rd row:** Attach Blue in front half of 1st st of last row and work same as 2nd row. Fasten off. Attach Yellow in end of foundation ch and work s c in opposite side of foundation chain. Ch 1, turn. Then work as for 2nd row. Fasten off. Attach Blue and work as for 3rd row. Fasten off.

For Ties, attach Yellow at one end of foundation chain, make a chain 8 inches long. Then work as for 1st

row of necklace. Fasten off. Attach Blue at other end of foundation chain and work same as Yellow Tie.

EARRINGS . . . With Yellow ch 5. Work exactly as for Necklace (4 rows of 2 petals each). Sew securely to earring base.

31—Star Necklace and Earring Set

MATERIALS:

CLARK'S O.N.T. or J. & P. COATS PEARL COTTON, size 5, 2 balls of Blue and 1 ball each of Red and White.

Steel crochet hooks Nos. 2 and 7.
2 earring bases.

NECKLACE — NECKBAND . . .

With double strand of Blue and No. 2 hook ch 115 to measure 17 inches. **1st row:** D c in 4th ch from hook, d c in 3 ch, * 2 d c in next ch, d c in 5 ch. Repeat from * 17 more times. Ch 1, turn. **2nd row:** * S c in 9 sts, 2 s c in next st. Repeat from * across. Ch 1, turn. **3rd row:** S c in each st across. Fasten off.

STARS . . . With single strand of Red, and No. 7 hook, ch 2. **1st rnd:** 10 s c in 2nd ch from hook. Join with sl st to 1st s c made. **2nd rnd:** * Ch 4, s c in 2nd ch from hook, h d c in next ch, d c in next ch, skip 1 s c, sl st in next s c (a point made). Repeat from * around (5 points). Join and fasten off. Make another piece same as this but do not fasten off. Place both pieces together and work s c through both thicknesses around all 5 points. Fasten off. Make 4 more same as this. Then make 4 White and 3 Blue. Sew 2 points of a Red star to center front of Neckband. Sew 2 Red stars on both sides of center star having 1 inch between. Sew 2 points of each White star between lower points of Red stars. Sew 1 point of each Blue star to bottom free point of 3 center Red stars. Sew on snap fastener to fasten.

EARRINGS . . . Make 2 Blue Stars as on Necklace and sew to earring bases.

32—Wool Pocket

MATERIALS:

CHADWICK'S RED HEART SHETLAND FLOSS, approximately 8 yards.

A steel crochet hook No. 3.

Ch 23. **1st row:** D c in 8th ch from

hook, * ch 2, skip 2 ch, d c in next ch. Repeat from * across (6 sps). Ch 3, turn. **2nd row:** (2 d c in next sp, d c in next d c) 5 times, 20 d c in next sp, (d c in base of next d c, 2 d c in next sp) 5 times, d c in base of last d c, ch 5, turn. **3rd row:** (Skip 2 d c, d c in next d c) 7 times, ch 5, d c in same place as last d c, (ch 2, skip 2 d c, d c in next d c) 3 times, ch 5, d c in same place as last d c, (ch 2, skip 2 d c, d c in next d c) 7 times. Ch 3, turn. **4th row:** (2 d c in next sp, d c in next d c) 7 times, 11 d c in next sp, (d c in next d c, 2 d c in next sp) 3 times, d c in next d c, 11 d c in next sp, d c in next d c, (2 d c in next sp, d c in next d c) 7 times. Ch 3, turn. **5th row:** (Skip 2 d c, d c in next d c) 9 times, ch 5, d c in same place as last d c, (ch 2, skip 2 d c, d c in next d c) 7 times, ch 5, d c in same place as last d c, (ch 2, skip 2 dc, d c in next d c) 9 times. Ch 3, turn. **6th row:** D c in each d c, 2 d c in each sp, 11 d c in each corner sp. Ch 6, turn. **7th row:** * Skip 2 d c, s c in next d c, ch 5. Repeat from * around. Ch 1, turn. **8th row:** In each loop make 3 s c, ch 3 and 3 s c; then work s c across top of pocket. Fasten off.

33A & B—Wool Edgings

MATERIALS:

CHADWICK'S RED HEART SHETLAND FLOSS, odd pieces.

Steel crochet hook No. 3.

33A . . . Ch 4. **1st row:** In 4th ch from hook make 3 d c, ch 3, s c in 3rd ch from hook (p), and 4 d c (a shell), ch 9, turn. **2nd row:** S c in 9th ch from hook, ch 3, sl st in p. Ch 3, turn. **3rd row:** Shell in same p, s c in next loop, ch 3, s c in next loop. Ch 5, turn. **4th row:** S c in next loop, ch 3, sl st in p, ch 3, turn. Repeat 3rd and 4th rows for pattern.

33B . . . ** Ch 3, * insert hook in 3rd ch from hook and pull loop through; yarn over. Repeat from * 3 more times, and draw through all loops on hook—an s c-cluster made. Repeat from ** for length desired. Ch 5, turn. Now work along one long edge (where single loops between clusters appear) as follows: **1st row:** In each single loop between clusters make d c, ch 2 and d c. Ch 1, turn. **2nd row:** * 3 s c in next sp, skip 2 d c, s c in next sp, in same sp make (ch 5, s c) 3 times; skip next 2 d c. Repeat from * across. Fasten off.

Cutting Up IN A BIG WAY

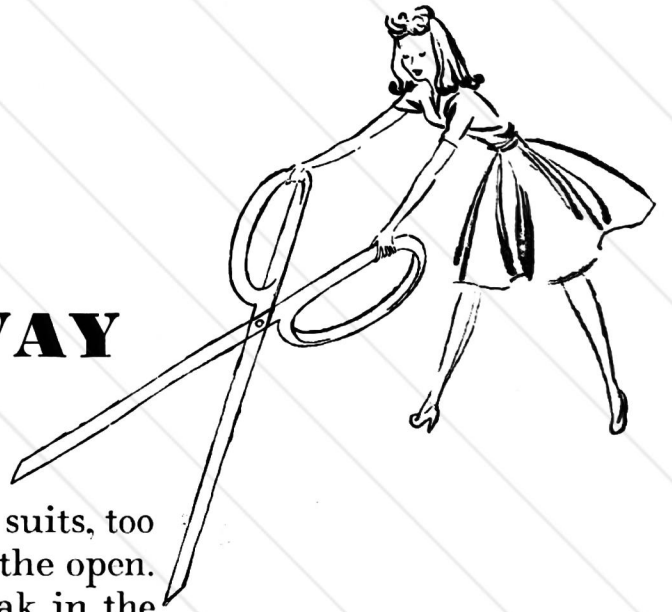

Chances are your closets have their quota of old coats and suits, too good to give away but too antiquated in cut to come out in the open. Every home has its collection of tired dresses, shirts weak in the collar. And nowadays many have a number of suits — made of precious priority wools — drooping forlorn and unworn on their hangers while their owners are away wearing Uncle Sam's latest models.

If you only knew it, there's probably a whole winter's wardrobe for you and your family waiting to be rescued from the moths. Frocks, rompers and sunsuits for your small fry, blouses and underwear for you out of old shirts; a snug reefer for Junior out of an old suit coat or a pair of flannel trousers. Pinafores and bathing suits emerge like painted butterflies from the chrysalis of old dresses and the tailored suit you've always had your heart set on is yours for the making out of a man's suit.

There's probably no satisfaction to equal the thrill of making something out of nothing. It takes only a little wit, time and patience to turn total losses into handsome profits!

GENERAL RECOMMENDATIONS

I. Is It Worth While To Make Over

When making over clothing, the first consideration is whether the material is in sufficiently good condition to warrant the time spent on it.

Woolen material may often be turned to the wrong side if the outer part is worn and threadbare. Even when a material has a pronounced right and wrong side, it may often be reversed with good results. Small holes and tears may be darned or covered with a decorative detail.

Cottons, silks and rayons should be held up to the light to see weak spots around the places where tears or breaks have already occurred. It may still be possible to use other parts.

II. Selection of Suitable Pattern

When you have determined the desirability of making over, the next step is to choose a pattern suitable to the style and the material. On the following pages suggestions are made which may offer some inspiration and guidance in making the most of what you have on hand.

III. Cleaning

It is preferable to have garments washed or dry cleaned before starting to rip as it is more pleasant to work with a clean fabric.

IV. To Rip or Not To Rip

Whenever the size of a garment permits, it is advisable to cut it apart at the seams. When the garment is to be ripped there are two methods that are acceptable.

Method No. I . . . Clip a thread and rip out a few stitches with the head of a needle until there is enough to grasp. Pull the thread until it breaks. Turn garment to the other side and pull the thread until it breaks. Continue this method of working from one side to another until the seam is ripped. This method has the advantage of not leaving any threads in the seams.

Method No. II . . . Rip seams with a stiff one-edged razor blade or better still, buy a gadget in which a two-edged razor blade may be screwed.

V. Preparation of Material

After material has been ripped it should be pressed carefully (see p. 49). It may be desirable to mark the straight of the goods as well as the right and wrong side of each section. Now the material is ready for the pattern. It is laid on and cut just the same as if the material were new.

You Have the Goods

ON HIM

No. 1 . . . page 36



No. 2 . . . page 37*



No. 3
page 38

MAKING OVER A MAN'S SUIT

Refer to general instructions on remodelling before attempting to make over a man's suit into a woman's suit. The considerations which pertain particularly to this problem follow:

SIZE

When making a man's suit into a woman's suit, size is an important consideration. The man must be larger than the woman for whom the suit is planned.

CAN YOU KEEP ANY OF THE TAILORING?

This consideration should govern your choice of pattern. *Some of the tailoring may be kept*, along the front edges and the pockets. If it is retained, the pattern bought must resemble as nearly as possible the original suit. Layout No. 2, p. 37, was planned for a problem of this kind. Remember if the front is not ripped, the coat will button like a man's from left to right, but many a good fashion was born of necessity. *The jacket will have to be completely ripped:*

1. If you wish to change buttonholes to the right side.
2. If you wish to turn worn material.
3. If you are working on a double breasted coat.
4. If the existing tailoring is too exaggerated.

CHOOSING A PATTERN

Patterns for women's suits have a wide variety of designs, but when choosing a pattern for remodelling, remember that men's suits in general have certain characteristics: a seam down the back, two darts at the waist, a side pocket on the left, and frequently flap pockets.

The limitations of material in the trousers make it necessary for the skirt to be fairly straight. A kick pleat or a slight flare is the most you can expect.

The pattern layouts on pages 36-39 were prepared to help you: first, to choose a pattern to fit as many of these requirements as possible; then, to make the adjustments necessary. The patterns were not chosen because they were the only ones which could be used, but as suggestions to make your choice easy and practical. Although you see pictured four complete suits, not all are made of one pattern. Some are composed of separate skirts and jackets. The idea was that when looking for patterns you might be able to find a pattern similar to one of the skirts or one of the jackets. Then on one of the charts you would be able to see how the particular problems of the coat and the skirt, which you chose, were worked out.

CORRECT SIZE OF PATTERN

The correct size of pattern is essential. A tape measure held over the bust and hips with ease so that the finger may be slipped under it, but drawn more snugly around the waist, will give your correct measurements. Check these measurements with the size chart given on every pattern envelope.

LINING

Usually it is not advisable to use the old lining. Rayon twill is a very serviceable material although silk and other rayons may also be used.

When lining is used, it is cut from the jacket pattern allowing two inches at center back for soft pleat. Pattern instructions give details.

INTERFACINGS

The collar and facings of a suit must have interfacings. You may use the interfacing already on the suit. If that seems too heavy, a lightweight muslin or percaline will do. The material must be shrunk before using.

This is done by washing the material and pressing while still damp. Do the same with the old interfacing, if you use it, so as to renew the "body." Cut interfacing for front facings from same pattern as front facings and on the straight grain. Cut the interfacing for the collar from under collar pattern, cutting on the bias. This makes the collar lie more smoothly.

CLEANING AND RIPPING

See general directions on p. 31, but when sending the suit to be cleaned, instruct the tailor not to press the crease in the trousers.

On trousers, rip completely along seams. The coat must be entirely ripped, if you intend to turn the fabric. Otherwise there are certain general ripping instructions: remove

lining and padding, take out sleeves and rip them apart, rip collar from neckline. Rip shoulder, underarm and back seams.

Instruction for ripping more than

this will be given on the pages with pattern layouts as it varies with the type of pattern you choose and whether you intend to retain the tailoring.

LIST OF PATTERNS USED ON PATTERN LAYOUTS

Layout I	JACKET and SKIRT	HOLLYWOOD 949	pg. 36
Layout II	JACKET and SKIRT	ADVANCE 2997	pg. 37
	OR SKIRT	BUTTERICK 1056	
	OR SKIRT	HOLLYWOOD 682	
	OR SKIRT	SIMPLICITY 3652	
Layout III	JACKET—VOGUE 9137—SKIRT—VOGUE 9001		pg. 38
	OR JACKET	HOLLYWOOD 800	
	OR JACKET	ADVANCE 2617	
	OR JACKET	SIMPLICITY 3652	
Layout IV	BOLERO—VOGUE 9344—SKIRT—VOGUE 9284		pg. 39
	OR BOLERO	BUTTERICK 1979	
	OR BOLERO	HOLLYWOOD 838	
	OR BOLERO	McCALL 4188	

GENERAL DIRECTIONS FOR CUTTING

1. All ripped pieces must be thoroughly pressed and threads removed, see p. 31.
2. Pin together corresponding parts, same sides of fabric together: front sections of trousers, back sections of trousers, upper sections of sleeves, under sections of sleeves, back sections of coat, front sections of coat, facings (if they have been ripped). This is to save time when cutting out the pattern, by cutting two sections at once. However the front sections of the coat should be cut separately if the tailoring is retained.
3. Take out pattern pieces needed.
4. Note perforations for straight of goods. Mark them with a colored pencil, as it is most important that these perforations be laid on the lengthwise grain (see p. 48).
5. Where there is a dart on the pattern at front shoulder, pin it up, matching perforations.
6. Turn to pattern layout in this book suitable to your pattern (find your pattern number on the list given just before this section and turn to the page indicated). Using the layout and the instructions given for each layout, cut out your pattern.

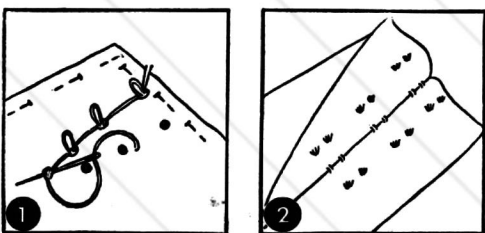

7. In the instructions which follow, there are certain words which have a special meaning: (a) *Lay your pattern on the fabric* means that in doing so, you *must* match the perforations for the straight of the goods to the lengthwise grain (see p. 48). (b) *Mark* means mark darts, seam allowances and other indicated points with tailor's tacks. To make tailor's tacks, use a double thread, and make a looped back stitch in each perforation, leaving a 1" loop (Fig. 1). Join perforations with a basting stitch. Clip the latter and remove pattern. Separate the two thicknesses of the fabric and cut the threads (Fig. 2). (c) *Cut* means cut around pattern, cutting notches away from pattern.

INSTRUCTIONS FOR CUTTING—LAYOUT No. 1, P. 36

For this jacket, the coat of the suit was almost entirely ripped apart. The one exception was the dart that goes straight up from the pocket. The trousers were ripped as usual. This suit is cut with no adjustment. Lay your pattern on the pieces as shown, mark and cut. For Lining and Interfacing see p. 32.

INSTRUCTIONS FOR CUTTING—LAYOUT No. 2, P. 37

Jacket . . . For this jacket it was planned to retain some of the tailoring of the original coat, so the pockets, the two front darts, and the front edges from the collar joining just above the lapels are not ripped. The outer edge stitching is ripped down to the tip of the lapel and from the bottom up to the first button. The

interfacing is cut to the edge of the facing for the coat.

Back of Coat (Jacket Back)

1. Pin pattern to back sections of coat as shown. Mark seam allowances and shoulder darts, but disregard darts at waistline.
2. Cut around pattern and cut off extra piece of pattern.

Front of Coat (Jacket Front)

1. Each side will be cut separately.
2. Lay pattern (dart at shoulder already pinned) on front section as shown, with edge to edge and marking for pockets in line with pockets already in coat. The pockets on coat will be a little farther back than on pattern or their position may be a little higher or lower. This makes no difference, nor does it matter that the lapel point of pattern projects a little beyond fabric. Pin pattern in a few places.
3. To make pattern lie flat, a new dart must be cut from the neckline as shown. Draw a line from bottom perforation of pinned dart to the neckline, parallel to dart already in lower part of coat, and cut along this line.
4. Smooth pattern out and pin around it. Add piece cut from back, as shown, matching notches. To make it lie flat, slash at inner edge at waistline and pleat at outer edge, as shown. Pin, mark (do not forget new dart at shoulder) and cut around pattern except at front edges. Transfer notches at side seam to outer edge.

Continued on page 34

CUTTING DIRECTIONS

(Cont'd from page 33)

Skirt . . . The pattern for this skirt is made with inverted pleats at center back and center front. To change this to a four gored skirt, turn under pleat extensions on both back and front $\frac{1}{2}$ " beyond pleat perforations towards center edge. The $\frac{1}{2}$ " is for a seam allowance.

Back of Trousers (Skirt Front) Upper Collar is also cut from this section.

1. Lay Skirt Front pattern on back sections of trousers as shown. Pin.
2. If you wish additional fullness as indicated by dotted portion of diagram, measure down 11" from top edge along fold of pattern and mark. Continue line of lower edge of pattern to edge of fabric with a basting. Connect end of this line with point marked above, as shown. This is cutting line. Mark and cut.
3. After Skirt Front is cut, take one of remaining pieces and fold on lengthwise grain (see p. 48). Place Upper Collar pattern with perforations on fold. Mark and cut.

Front of Trousers (Skirt Back) Under Collar is also cut from this section.

1. Lay patterns on front sections of trousers, as shown.
2. If skirt pattern exceeds width of fabric, turn it back at side seam as shown, graduating in to hipline.
3. Pin, mark and cut.

Sleeves

1. Lay patterns on sleeve sections as shown.
2. Cut off the pattern piece that extends beyond the fabric of the Upper Sleeve and pin to Under Sleeve as indicated. When pinning notice that a small amount of width is added to keep the outer line curved. Mark and cut.

Belt

1. Cut belt from any remaining fabric. Piece at side seams if necessary.
2. If fabric is heavy, face with lining material.

Lining and Interfacings

See instructions for Linings and Interfacings, p. 32.

INSTRUCTIONS FOR CUTTING—LAYOUT No. 3, P. 38

Jacket . . . For this jacket the coat was entirely ripped apart except for the two front darts. If suit fabric is turned, front darts are ripped and sewed in again on the other side.

Back of Coat (Jacket Back)

There is no special problem. Pin pattern to back sections of coat, mark and cut.

Front of Coat (Jacket Front)

1. Both sides may be cut at one time. Lay pattern (dart at shoulder already pinned) on front coat sections as shown, so that front edge comes just to the buttonholes. The buttonholes may run a little into the seam allowance but this is of no consequence. Pocket perforations should come above the pocket slash. Pin pattern in a few places.
2. To make pattern lie flat, a new dart must be cut from the armhole to lower perforation of shoulder dart as indicated. It should come below pocket slash.
3. Smooth pattern out and pin all around. If rever of pattern seems to extend out a little too far, take a small pleat in it, graduating it as shown. Mark seam allowances and new dart. Disregard waistline darts on pattern. When fitting coat it may be necessary to take in existing darts a little.

Front Facings . . . Lay pattern on so that front edge is in back of buttonholes. If rever of Jacket Front was made smaller by a pleat, take the same pleat in the Facing as was taken in the front. Pin, mark, and cut. It makes no difference if facings are a little narrower than the pattern. Allow the extra piece on the lining.

Skirt . . .

Front of Trousers (Skirt Front) Pockets are also cut from this section.

1. Lay Skirt Front on front sections of trousers as shown. Be sure it is far enough from the edge to allow for seam at outer edge and far enough down so that pockets may be cut from piece above. Pin, mark and cut.
2. Pin Pockets on remaining pieces as indicated. By cutting on bias (see p. 48) as shown, a nice effect is produced in a herringbone tweed. Pockets may also be cut straight.

Back of Trousers (Skirt Back) Collars and Pleat Insert are also cut from this section.

1. Lay Skirt Back on back sections of trousers so that pleat extension is on lengthwise grain of fabric. Pin, mark and cut.
2. From one of two remaining pieces the Collars are cut. Pattern pieces are shown in proper position. From the other piece the Pleat Insert is cut with the center back on a lengthwise fold.

Sleeves . . . See instructions for Sleeves under Layout No. 2, p. 34.

Belt . . . See instructions for Belt under Layout No. 2, p. 34.

Lining and Interfacings . . . See instructions for Linings and Interfacings, p. 32.

INSTRUCTIONS FOR CUTTING—LAYOUT No. 4, P. 39

Jacket . . .

Back of Coat (Jacket Back) Lower Front Facing is also cut from this section.

1. Pin Jacket Back to back sections of coat as shown, about $\frac{5}{8}$ of an inch in from center back to allow for seams. Mark and cut as usual.
2. Pin, mark, and cut Lower Front Facing from same piece.

Front of Coat (Jacket Front) Lower Back and Back Facings are also cut from this section.

1. Lay Jacket Front (dart already pinned) on front sections of coat above lower pocket openings and with edge at back of buttonholes. Pin in a few places.
2. To make pattern lie flat a new dart must be cut from lower edge as shown. About two inches beyond $\frac{1}{2}$ the distance from the front edge to the underarm seam, cut a slash which extends to the lowest perforation for the shoulder dart.
3. Smooth pattern out and pin.
4. Mark and cut in usual manner.
5. Pin, mark and cut Lower Back and Back Facings from same pieces.

Front Facings . . .

1. Pin Front Facing patterns to facing sections of coat as shown. Mark and cut.

Skirt . . .

This skirt pattern has three pieces, one for the front and two for the back. The two back portions are pinned together as shown. The result is a four gored skirt.

Front of Trousers (Skirt Back)

1. Pin back sections of pattern together, lapping the pieces by matching seam perforations from hipline to lower edge and allowing them to spread from hipline to upper edge.
2. Lay pattern on front sections of trousers as shown, allowing about $\frac{1}{2}$ inch at edge for seam allowance. If pattern extends beyond fabric, turn back equal amount from upper to lower edge as shown. The notches are transferred to outer edge. Measure amount pattern pieces spread at back and take this amount from

back seam as shown. Pin, mark and cut.

3. Cut off piece of pattern turned back.

Back of Trousers (Skirt Front)

1. Lay pattern on back sections of trousers as shown, adding the piece cut off back, as shown, matching notches. Pin, mark and cut. Transfer the notches.

Sleeves . . . The sleeves of this pattern are made in one piece and will not be suitable for use in this bolero jacket. Use a two-section sleeve pattern from a jacket pattern of the same make as the bolero. See instructions for Sleeve under Layout No. 2, p. 34.

Belt . . . See instructions for Belt, Layout No. 2, p. 34.

Lining and Interfacings . . . See instructions for Linings and Interfacings, p. 32.

HINTS ON TAILORING

Pressing . . . It cannot be repeated too often that pressing is the secret of successful sewing, especially tailoring (see general instructions on pressing, p. 49).

How to Finish Front and Collar of Suit When Tailoring Is Ripped

Interfacing and Taping on Front of Jacket

When the side seams are sewed and pressed, place jacket flat on table, wrong side out. Pin interfacings to fronts. Baste shoulder seams. Try on jacket (right side out) and pin together at front where top button will come. Turn back lapels to see where natural roll in collar occurs. Mark the line of the roll with pins.

Remove jacket and turn again to wrong side. A little beyond line of pins toward the armhole run a basting line. Using this line as a guide, secure the two fabrics together with diagonal bastings (Fig. 3), making sure to catch only the top layer of under fabric so that stitches do not show through. Diagonal basting is a straight up and down stitch, catching two thicknesses of fabric together combined with a slanting stitch on top of fabric. Work from inside out toward edge.

When this section is entirely covered with diagonal bastings check the lapels to see that they are even. The best way to do this is to make a cardboard form of the lapel pattern. Cut seam allowance off pattern. On a piece of cardboard trace around the lapel part of the pattern and cut out the form. Apply this form to the lapel and mark around it. The mark-

ing line is the new seam line. Baste entire facing to coat at seam line. Next baste twill tape, about 1/2" wide, flush with seam line, mitering the tape at the point of lapel. First sew edge to seam line with fine hemming stitch and then sew the other edge to the interfacing. Trim away seam allowance on the interfacing (Fig. 4).

Interfacing and Taping on Collar

For collar, stitch center seams in under section of collar and interfacing and press open. Baste the under section of collar and interfacing together around the seam allowance. Inside seam allowance, from notch to notch, make a curved row of machine stitching which reaches about 1/3 of the way up the collar (Fig. 5). Make several rows inside this row about 1/4" apart, as shown. Using top curved line as a guide, cover the rest of the collar with diagonal bastings, keeping within the seam line (Fig. 5). Tape top and side edges of collar in same way described for front facings. Cut away seam allowance on interlining.

Applying Collar and Facings

Baste and stitch under section of the collar to the jacket. Press seams open, clip seam allowance to make collar lie flat and tape seam line as before. Baste and stitch upper section of collar to front facings. Press seams open and clip.

Pin facings and collar to jacket, right sides together and stitch around, using outside of tape as a guide line. Clip off corners. Trim off seams, one a little narrower than the other. Turn facing to wrong side of jacket. Baste and press. The entire outer edge may be machine stitched close to edge. If you wish to omit the machine stitching there is another way of preventing the facing from rolling to the right side. Begin at bottom of coat, and on the wrong side sew close to the edge with a combination of back and blind stitches (see p. 48). These stitches must be firm but not tight and should catch the seam allowance and facing together. If there is a lapel, reverse the work at the point where the lapel begins. Turn hem on jacket and catch stitch (see p. 48). Baste inner edge of facing to inside of jacket, turning rever out while doing so, to make

sure it is not too tight. Catch stitch to jacket.

How to Finish Front and Collar of Suit When Tailoring Is Retained

Prepare under section of collar as described under Interfacing and Taping on Collar. Seam under section of collar to jacket, right side to right side and press. Turn facing out over the right side of jacket. At lower edge of jacket, stitch facing and front together, continuing original seam. At neck edge, stitch upper section of collar to facings (the collar will be placed under the facings, right side of collar and to right side of facings). Press seam open. Sew upper and under sections of collar together, continuing the stitching down the edge of the rever and keeping an even line until it merges with old seam. Trim seams, clip corners and turn facing to inside of jacket. Baste around outer edge of collar and rever and lower edge of jacket. Press. Finish edges with stitching the same as front edge stitch. To hide ends of thread leave long enough ends when finishing off machine stitching to thread a needle and bring the ends through to the inside of jacket. Turn lower hem and catch stitch to coat. Baste inner edge of facing to inside of jacket, turning rever out while doing so to make sure that it is not too tight. Catch stitch to jacket.

Skirts . . . On all of the skirts there will be a center seam back and front and side seams. Where there is an inserted pleat the pattern instructions will give details.

How to Cover Pocket Openings . . .

To close pocket openings, cut strips of lining fabric 1 3/4" wide and the length of the openings plus one inch. Press or baste 1/2 inch seams around all edges of strips. Baste on right side of openings, keeping fabric smooth. Stitch strips on edges. Press with a damp cloth. These strips will be hidden by the pockets. On the bolero you may wish to use a pocket of the same material as the jacket. If the material is a dark smooth fabric, a pocket or even a band of faille ribbon would be very attractive.

Lining . . . See pattern instructions and How to Sew in Lining, page 12.

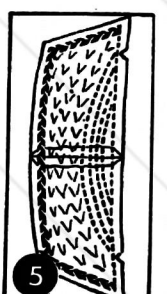
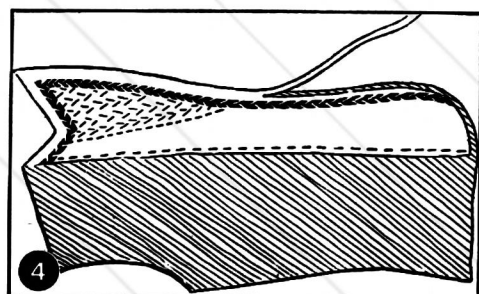
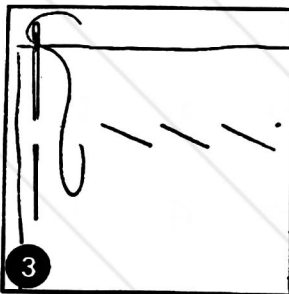

Layout No. 1

JACKET AND SKIRT HOLLYWOOD 949

This suit is cut out without any special adjustment by laying the pieces on the suit as directed. The original suit was entirely ripped except for the dart which comes straight up from the pocket.

When making the suit, follow the pattern directions carefully. Special tailoring hints — page 35; easy sewing suggestions—page 48; full cutting instructions—page 33.



This drawing and the picture on page 32 show the suit as it appears when completely remade.

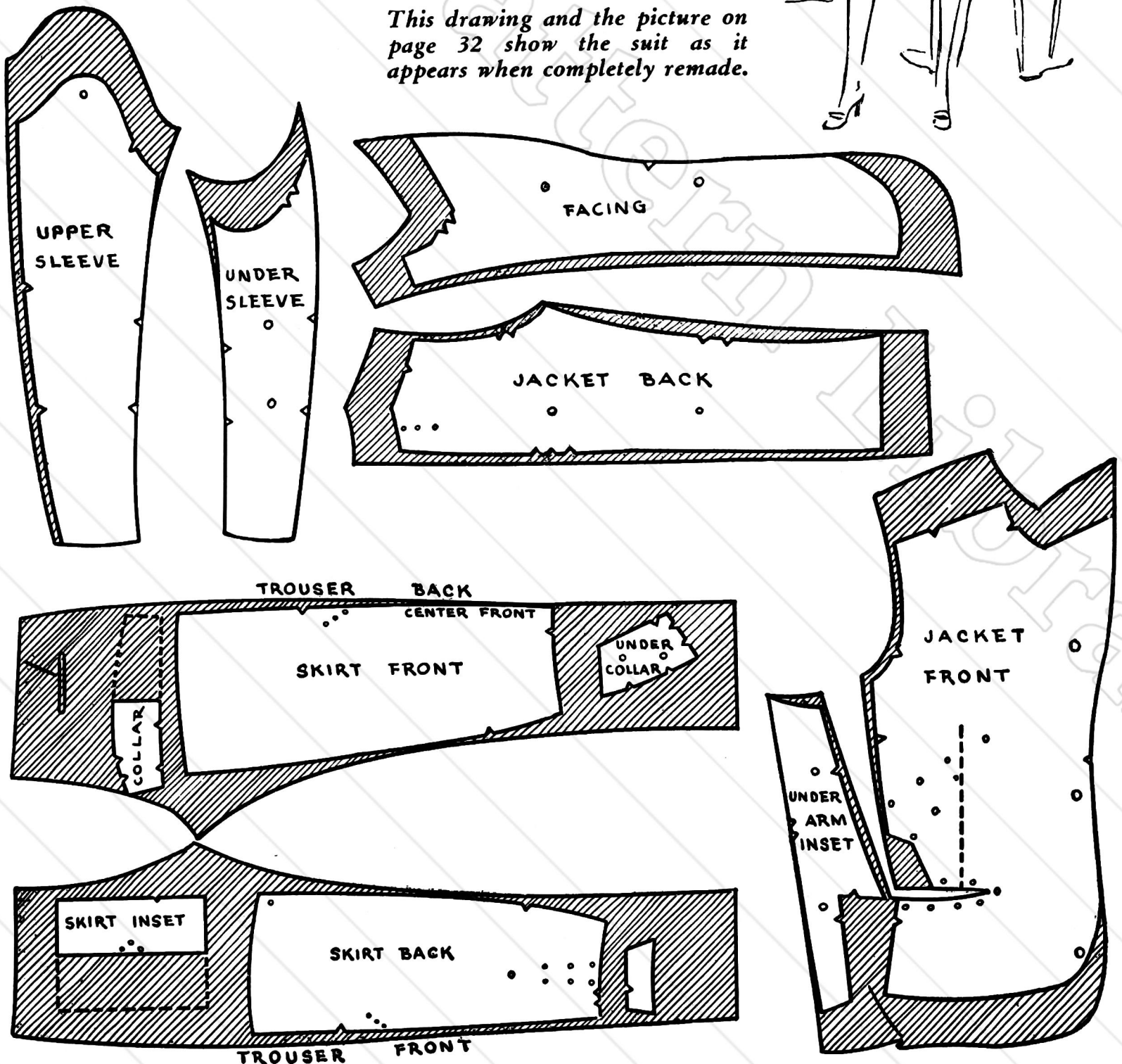

Layout No. 2

JACKET AND SKIRT

ADVANCE 2997

This jacket pattern was chosen so that some of the tailoring of the coat might be retained. It has pockets similar to those on a man's suit and the other features necessary. Notice that when the coat is made over, the tailoring along the edge from the lapel down is not cut to conform to the pattern but kept "as is."

The parts of this coat which were not ripped were the pockets, the two front darts, the front edges from the collar joining. The outer edge stitching was ripped down to the tip of the lapel and from the bottom up to the last button.

The skirt pattern has one pleat down the center back and front. When cutting the pattern the pleat is removed as shown and a slightly flared four gored skirt results.

Other skirts that may be used for the same effect—Butterick 1056, Hollywood 682, Simplicity 3652.

Full cutting instructions—page 33; special tailoring hints—page 35; easy sewing suggestions—page 48.



This drawing and the picture on page 32 show the suit as it appears when completely remade.

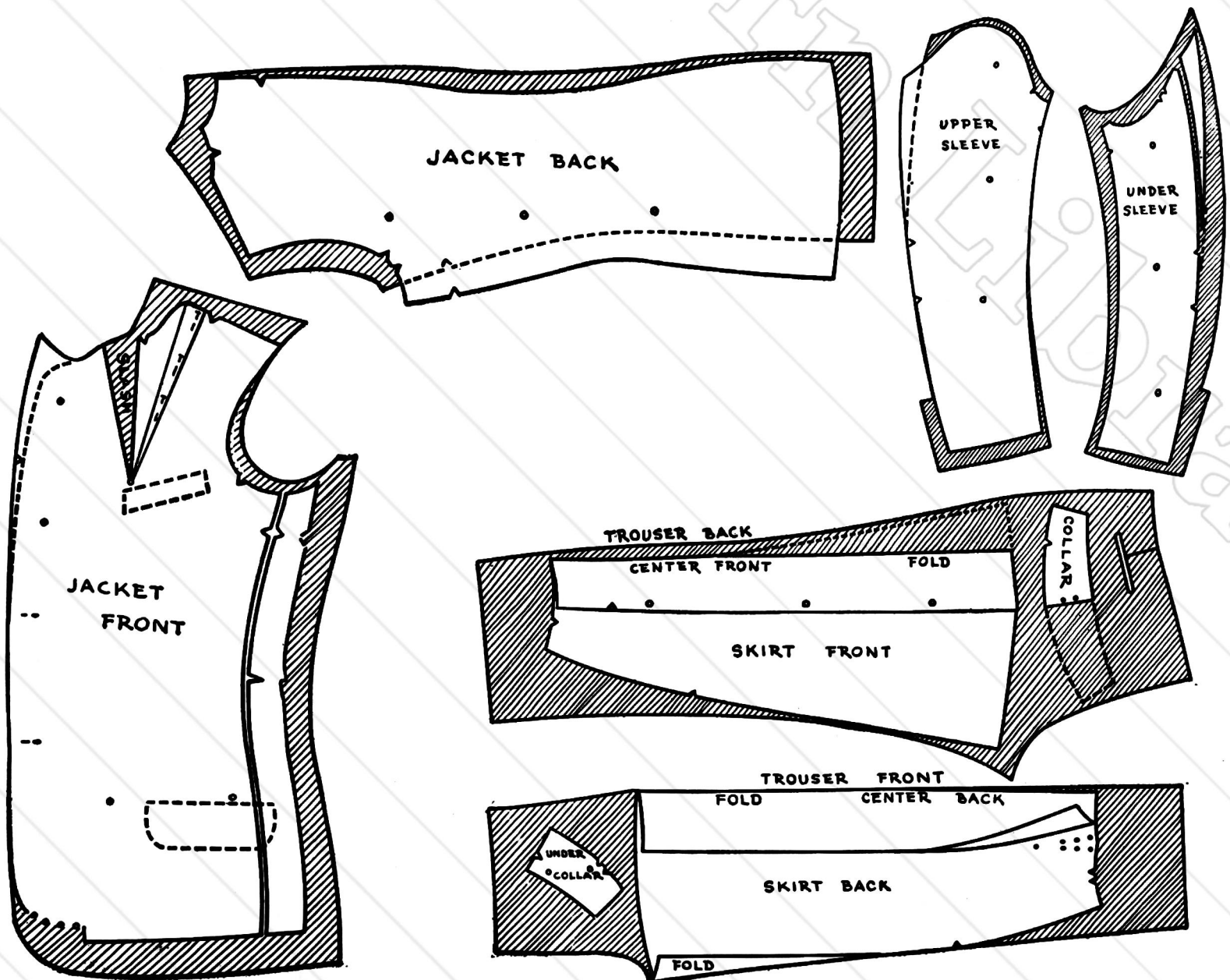

Layout No. 3

JACKET-VOGUE 9137

For this jacket pattern, the coat was entirely ripped apart except for the two front darts. If suit fabric is turned, front darts are ripped and sewed in again on the other side. Directions are given on page 35 for closing the pocket slits which are then covered with patch pockets. Sometimes an extra pocket is added at the top.

Other jacket patterns that may be used for the same effect, Hollywood 800, Advance 2617, Simplicity 3652.

SKIRT-VOGUE 9001

The skirt was chosen because it is straight and has a kick pleat in the back which can be easily cut from the material available.

Full cutting instructions — pages 33, 34; special tailoring hints — page 35; easy sewing suggestions — page 48.

This drawing and the picture on page 32 show the suit as it appears when completely remade.

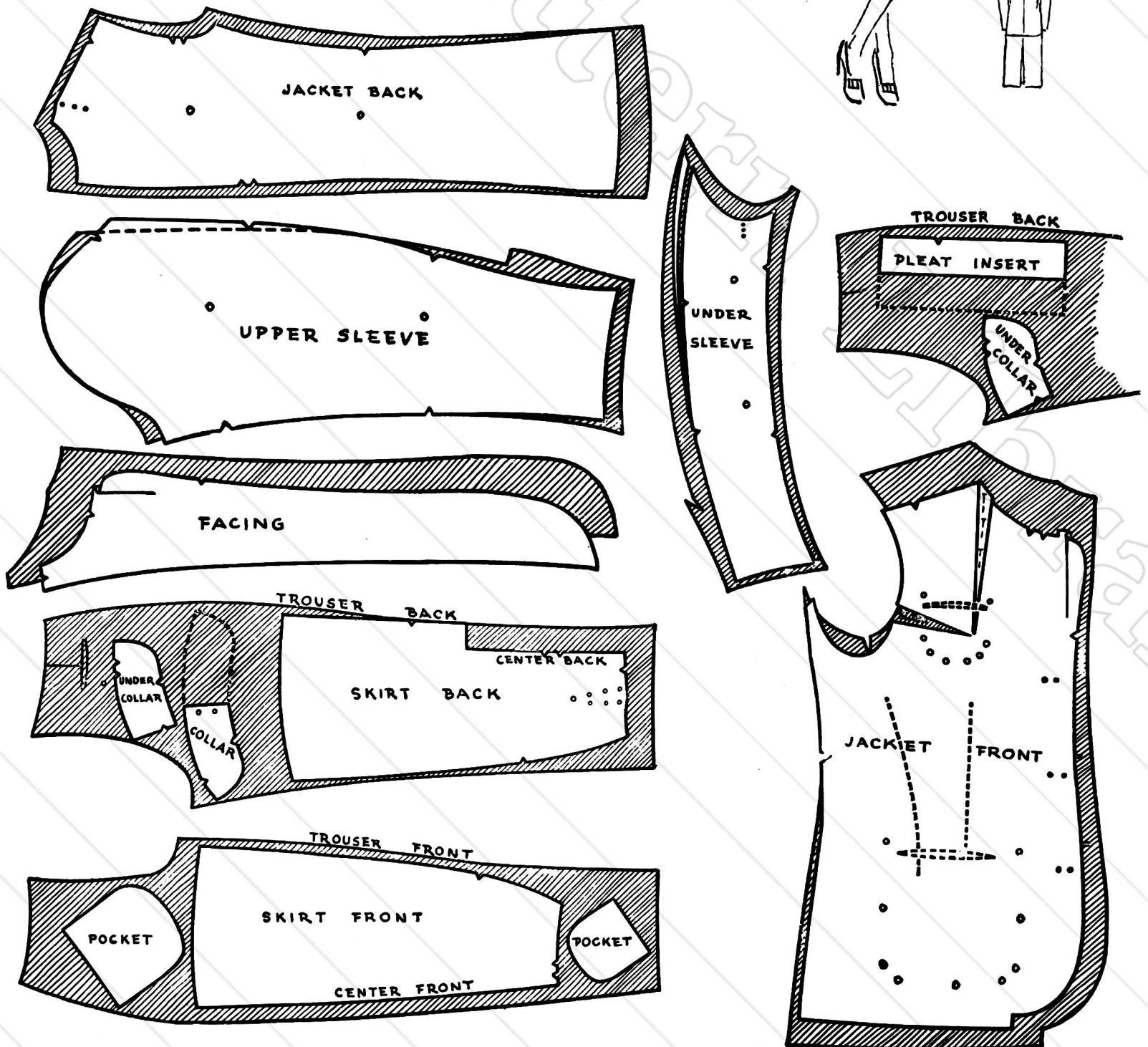
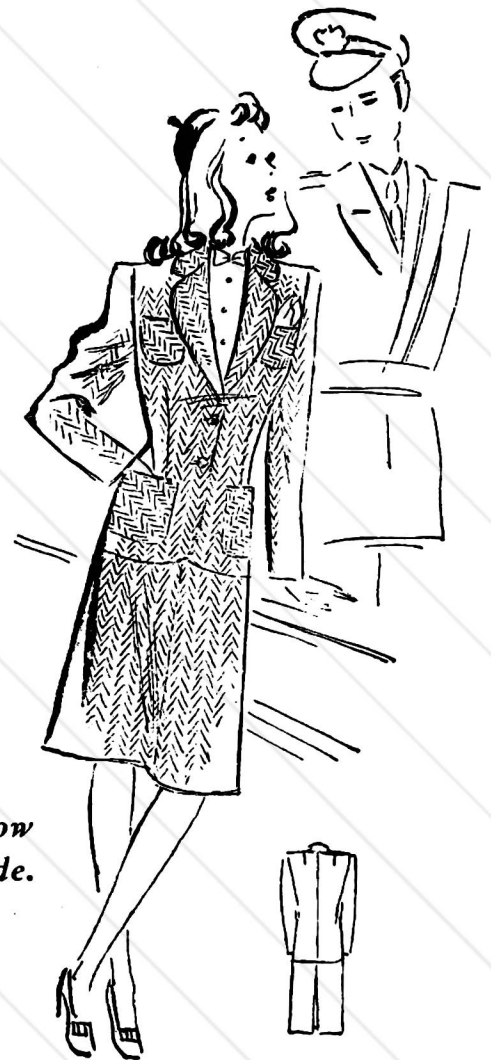

Layout No. 4

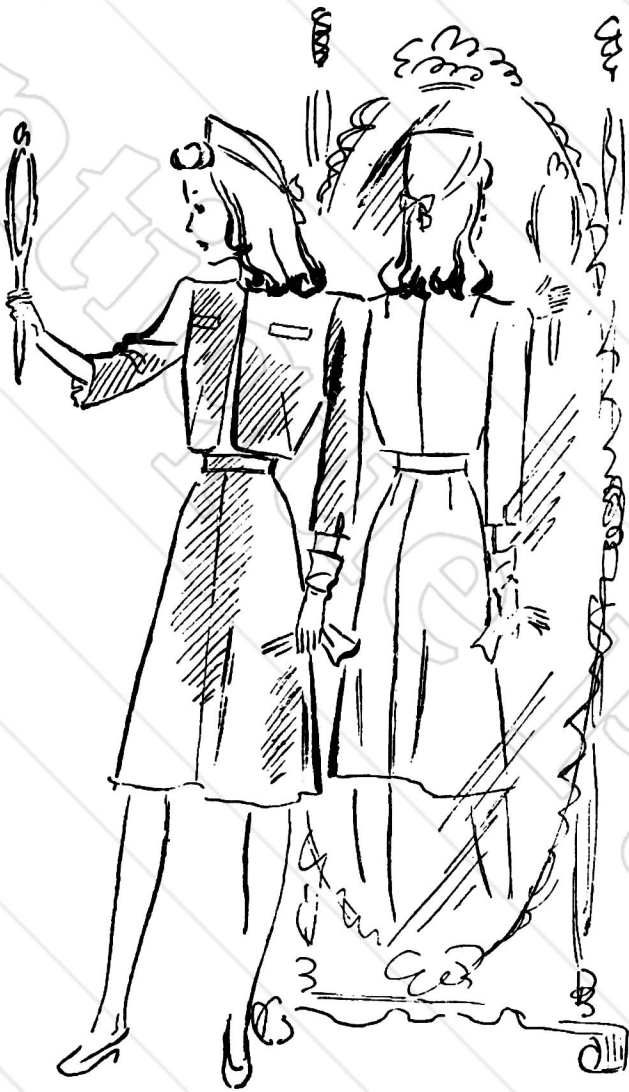

BOLERO-VOGUE 9344

To make the bolero, the coat must be entirely ripped. The pattern has no seam down the back but since the original suit is made with one, an allowance is made at the back for a seam. Directions are given for closing the pocket slit on page 35. This may be concealed by a pocket.

The sleeves of this pattern are made in one piece and will not be suitable for use in this bolero jacket. Use a two-section sleeve pattern from a jacket pattern of the same make as the bolero.

Other boleros which may be used are Butterick 1979, Hollywood 838, McCall 4188.

SKIRT-VOGUE 9284

The skirt was chosen because it can be easily converted into a four gored skirt. The pattern has three pieces — a front, a back, and a side back.

Full cutting instructions—pages 34, 35; special tailoring hints—p. 35; easy sewing suggestions—p. 48.

The drawing shows the suit as it appears when completely remade.

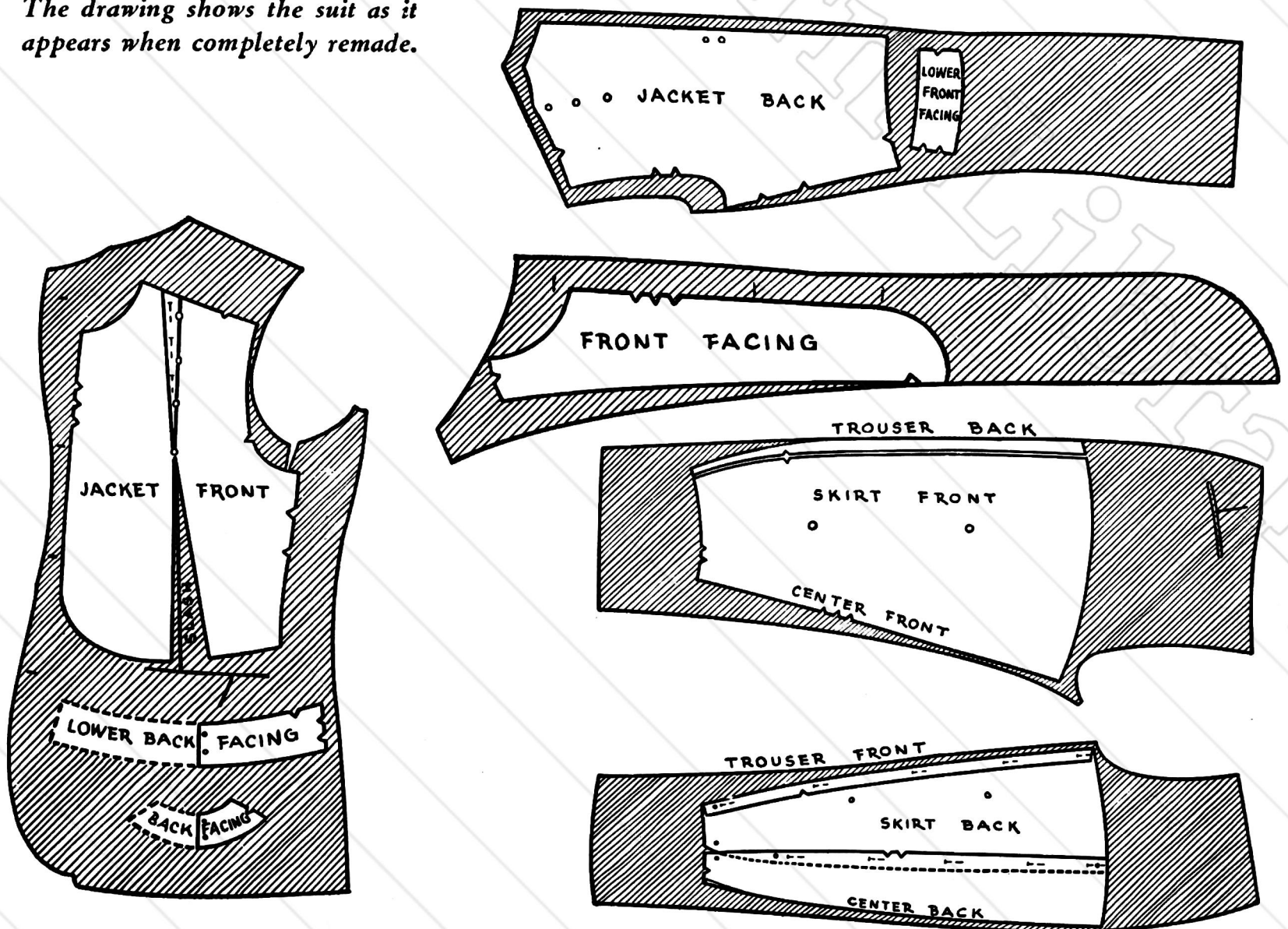

The Shirt off His Back

1



2

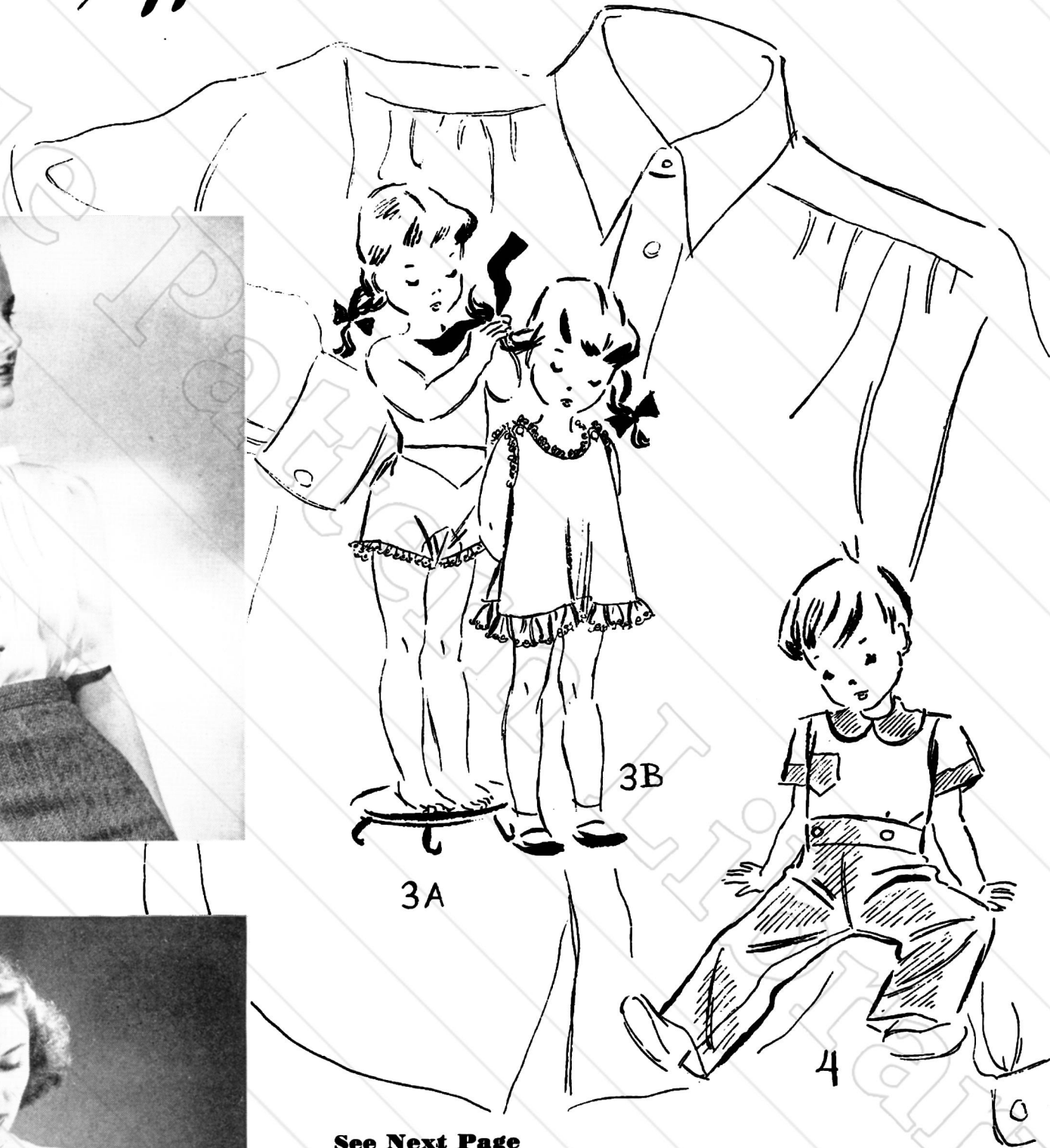

See Next Page
For Layouts For Cutting
These Garments From Men's Shirts

1. Girl's Blouse From Two White Broadcloth Shirts (McCall 3761). 2. Girl's Blouse From A Man's Shirt (McCall 4580). 3A-B. Child's Underwear From A Man's White Broadcloth Shirt (Simplicity 3645). 4. Child's Pajamas From Two Contrasting Shirts (Simplicity S615). 5. Child's Smocked Dress From A Man's Shirt (McCall 936). 6. Boy's Suit From Two Contrasting Shirts (Hollywood 948). 7. Child's Dress From Two Contrasting Shirts (Hollywood 950).

8. Child's Dress From A Striped Shirt (McCall 4553). **9.** Child's Overalls From A Striped Shirt (McCall 832 or DuBarry 2475B). **10.** Boy's Blouse From A Man's Shirt (Simplicity 1509 or DuBarry 2346B). **11.** Child's Sunsuit And Bonnet From A Man's Shirt (Simplicity 3272). **12.** Child's Pinafore From A Man's Shirt (Simplicity 2716).

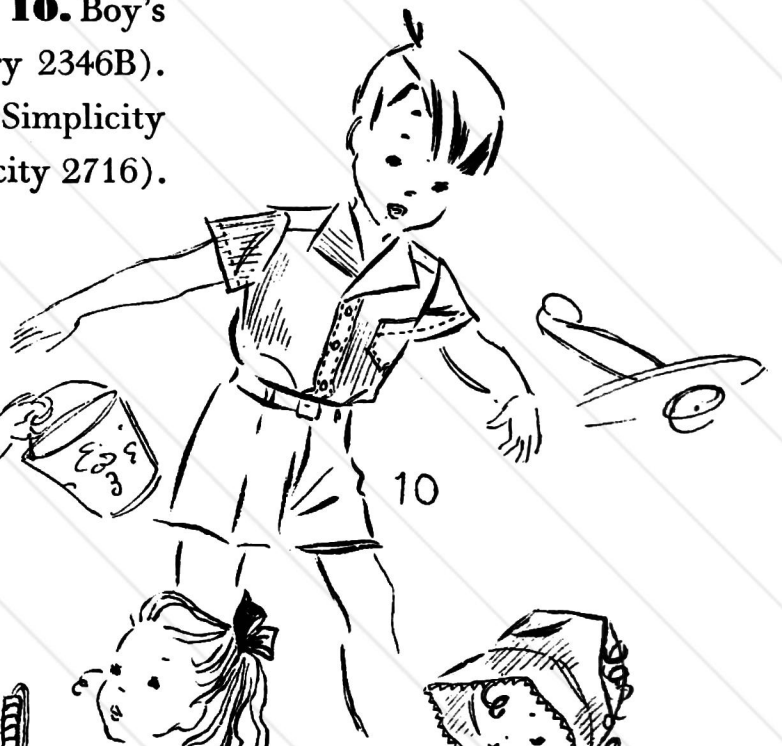

Layouts for Cutting Garments from Men's Shirts

<p>TRUSERS</p> <p>TRUSERS</p> <p>SIMPLICITY 615 CHILD'S PAJAMAS FROM A PLAIN & STRIPED SHIRT</p> <p>SLEEVES</p> <p>BLOUSE BACKS FOLD</p> <p>BLOUSE FRONTS</p>	<p>FRONT</p> <p>BACK</p> <p>2 FRONTS</p> <p>2 BACKS</p> <p>BELT TIE</p> <p>CUFFS</p> <p>CUFFS</p> <p>SLEEVES</p> <p>YOKES</p> <p>COLLARS</p> <p>M'CALL 936 SMOCKED DRESS FROM 2 WHITE SHIRTS</p>	<p>BLOUSE FRONTS</p> <p>BLOUSE BACK FOLD</p> <p>SLEEVES</p> <p>COLLARS</p> <p>SHORTS BACKS</p> <p>SHORTS FRONTS</p> <p>HOLLYWOOD 948 LITTLE BOYS SUIT FROM A PLAIN & STRIPED SHIRT</p>
<p>YOKE BACK</p> <p>BLOUSE</p> <p>SLEEVE BAND</p> <p>BACK</p> <p>SLEEVE</p> <p>SLEEVE</p> <p>FRONT</p> <p>WAIST BAND</p> <p>YOKE BACK</p> <p>FRONT</p> <p>FRONT</p> <p>M'CALL 4553 CHILD'S DRESS FROM A SHIRT</p>	<p>YOKE FRONTS</p> <p>YOKE BACK</p> <p>FRONTS</p> <p>BACK</p> <p>FOLD</p> <p>FRONT</p> <p>CUFFS</p> <p>SLEEVES</p> <p>HOLLYWOOD 950 CHILD'S DRESS FROM 2 SHIRTS (CUT CONTRASTING TRIM FROM SECOND SHIRT)</p>	<p>FRONTS</p> <p>BACKS</p> <p>BIB</p> <p>STRAP</p> <p>M'CALL 832 CHILD'S OVERALLS FROM A SHIRT</p>
<p>COLLAR</p> <p>FRONT</p> <p>FRONT</p> <p>BACKS</p> <p>YOKE</p> <p>SLEEVES</p> <p>SLEEVES</p> <p>M'CALL 3761 GIRL'S BLOUSE FROM 2 WHITE SHIRTS</p>	<p>FRONT</p> <p>BACK</p> <p>FOLD</p> <p>SLEEVES</p> <p>FACINGS</p> <p>M'CALL 4580 GIRL'S BLOUSE FROM A SHIRT</p>	<p>RUFFLES</p> <p>SLIP BACKS</p> <p>SLIP FRONT FOLD</p> <p>PANTIE BACK</p> <p>YOKE</p> <p>PANTIE FRONT</p> <p>RUFFLES</p> <p>SIMPLICITY 3645 CHILD'S SLIP AND PANTIE FROM A SHIRT</p>
<p>COLLAR</p> <p>YOKE</p> <p>COLLAR</p> <p>BACK</p> <p>FRONT</p> <p>SLEEVES</p> <p>FOLD</p> <p>SIMPLICITY 1509 BOY'S BLOUSE FROM A SHIRT</p>	<p>STRAPS</p> <p>FRONT</p> <p>BACK</p> <p>FOLD</p> <p>BONNET</p> <p>SIMPLICITY 3272 CHILD'S SUNSUIT AND BONNET FROM A SHIRT</p>	<p>BACK</p> <p>RUFFLES</p> <p>FRONT</p> <p>SIDE</p> <p>SIMPLICITY 2716 CHILD'S PINAFORE FROM A SHIRT</p>

There's Life in the Old Girl Yet

1. Jerkin From Dress (Advance 5047).
2. Jumper From Dress (Hollywood 499).
3. Jacket From Dress (McCall 4764).
4. Playsuit From Dress (Simplicity 3392).
5. Weskit From Jacket (Butterick 2098 or DuBarry 5416).



1



2



3



4



6



7

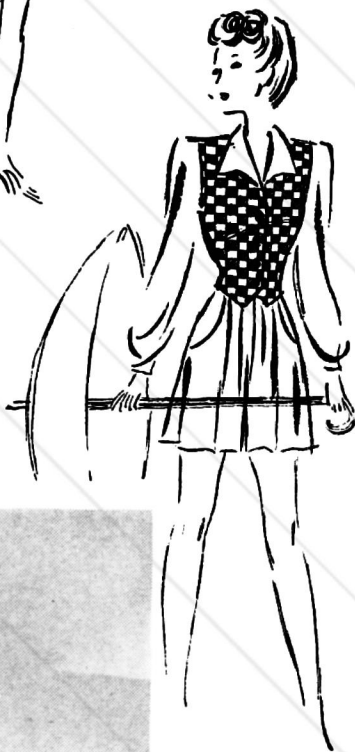

5



10. Bathing Suit From Dress (Simplicity 3885 or DuBarry 5372 for Shorts, Simplicity 3164 or DuBarry 5439 for Top).

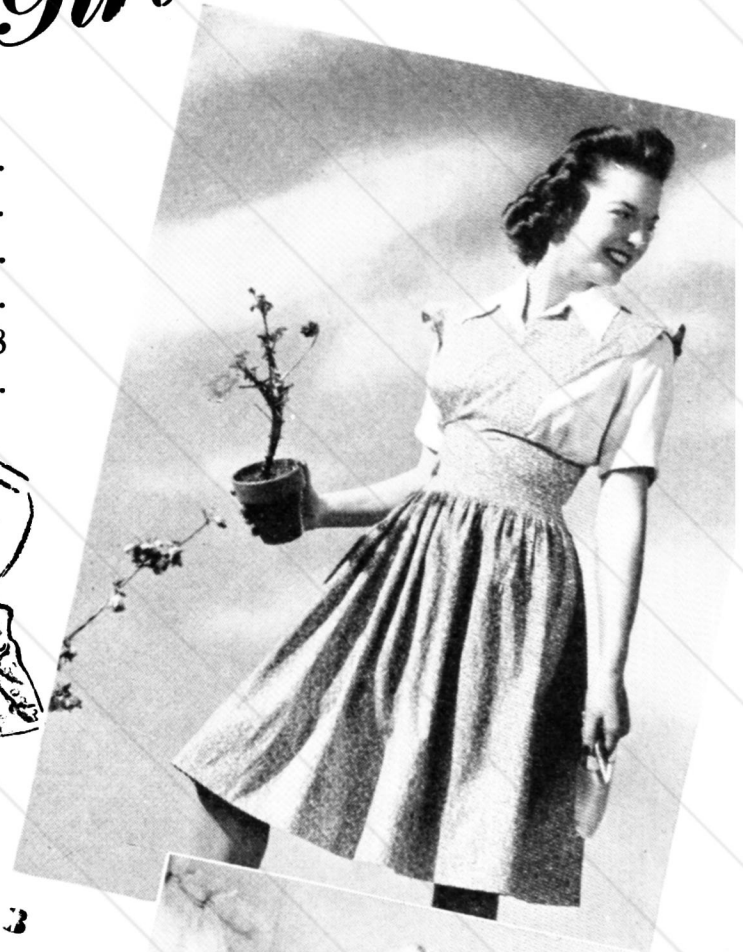

8



6. Bolero and Skirt From Coat (Simplicity 4221 for Bolero, 3885 for Skirt).
7. Daytime Dress From Evening Dress (Simplicity 4221).
- 8 and 9. Pinafores From Dresses by Cutting Out Sleeves and Underarm Sections.

Junior Editions



1. Girl's Weskit With Knitted Back and Matching Calot. Front Made From a Man's Vest. **2.** Girl's Slacks From a Man's Trousers (Butterick 2162). **3.** Girl's Coat From A Man's Coat (Butterick 2237 or DuBarry 5452).

See Page 47 For Directions For Knitted Back and Calot.

1



4. Child's Overalls From A Corduroy Bathrobe (Simplicity 4116).

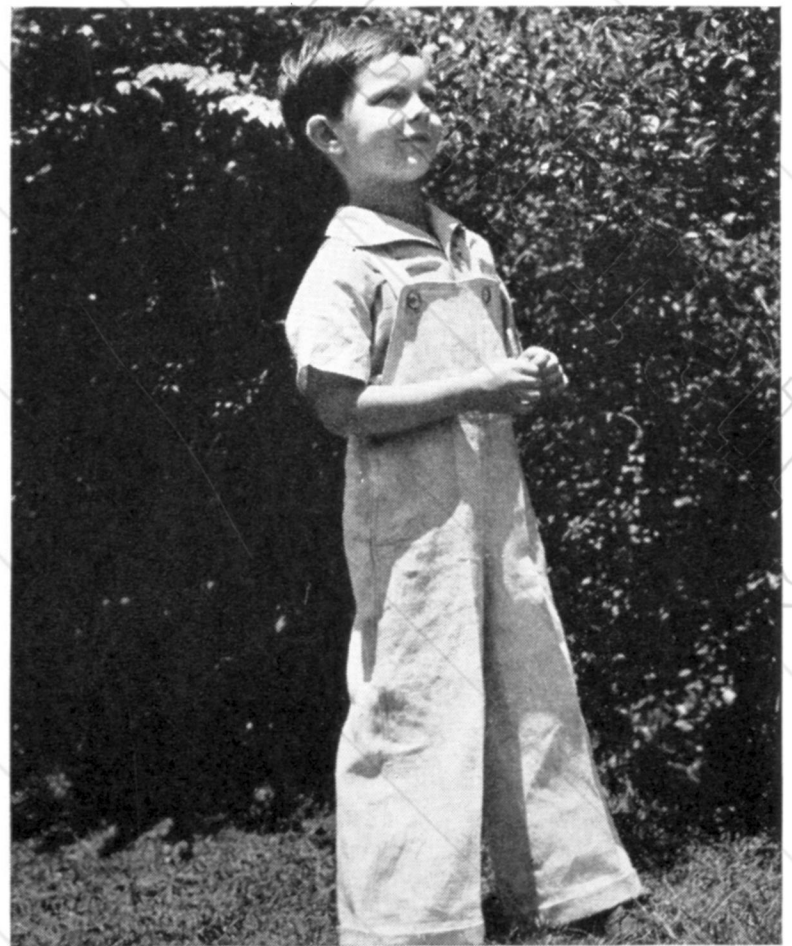

2

3

4

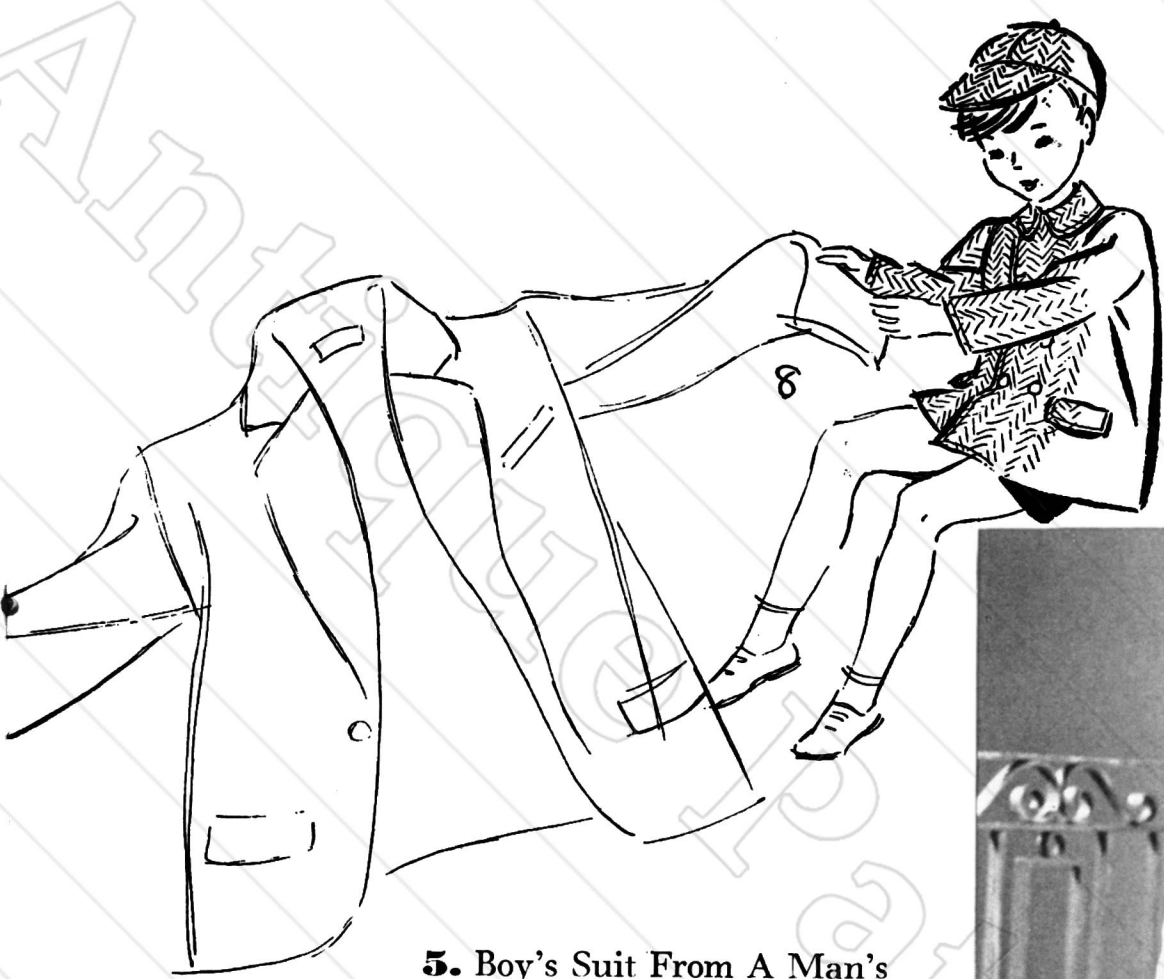

8. Boy's Coat From A Man's Coat (Butterick 2205).

5. Boy's Suit From A Man's Suit (Butterick 2180).

6. Child's Overalls, Jacket, Cap from A Flannel Bathrobe (Simplicity 4114).

7. Child's Coat from a Man's White Flannel Trousers (McCall 4222).

See Next Page For Layouts For Cutting These Garments

7

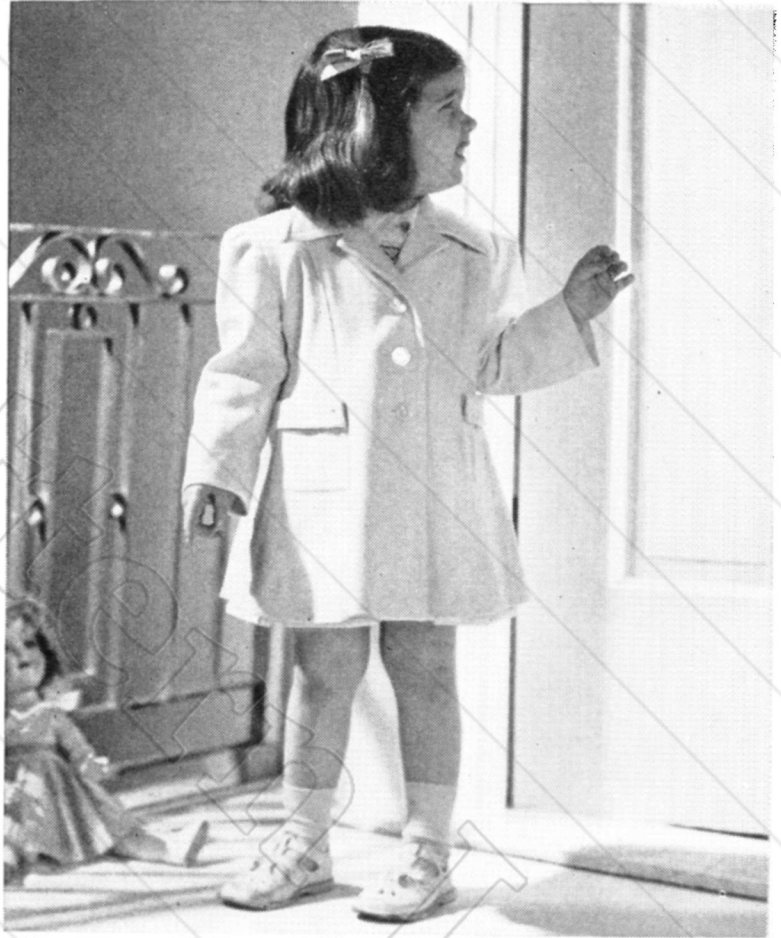

5



6

Layout for Cutting Junior Garments

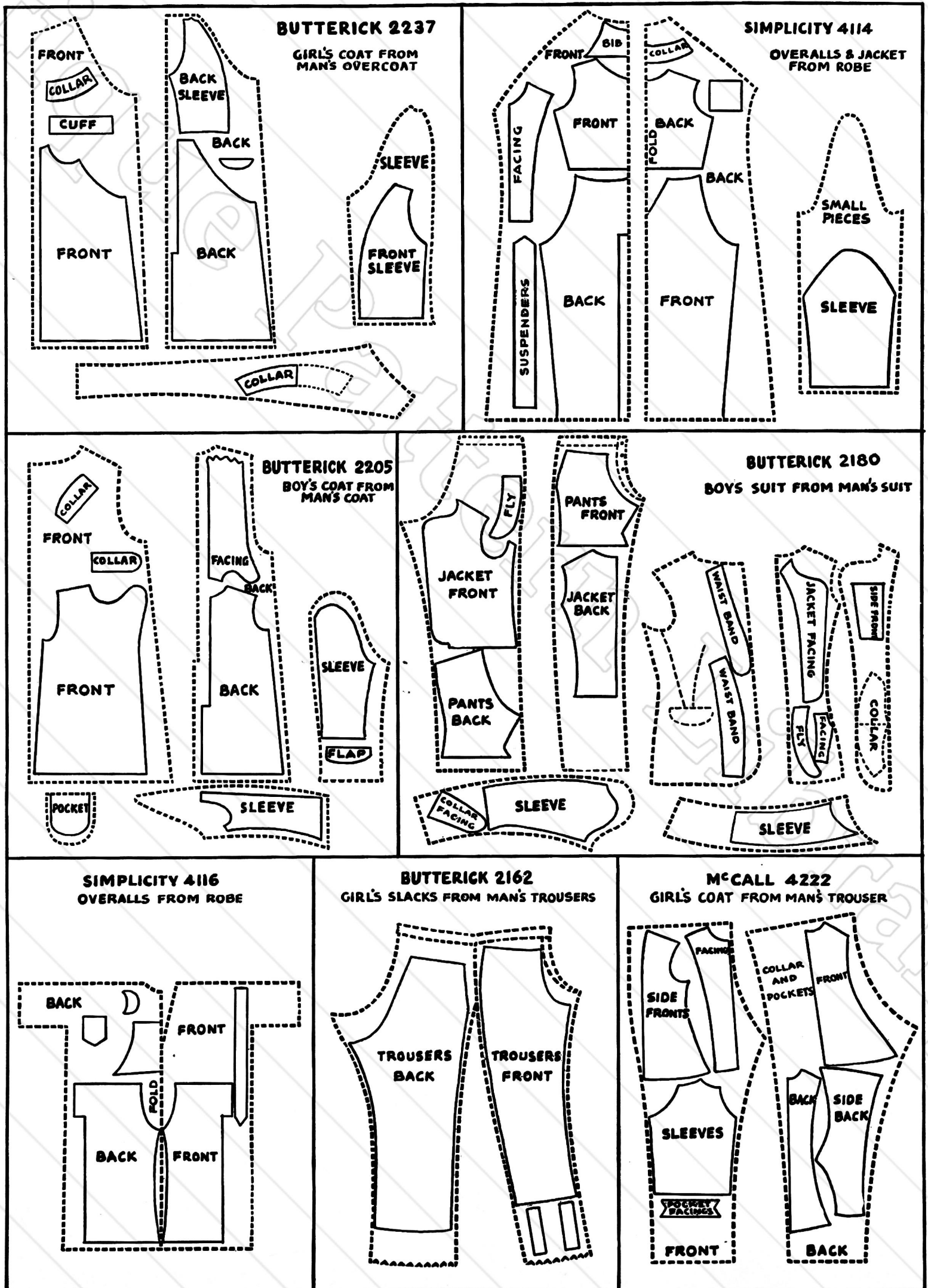

GIRL'S WESKIT FROM MAN'S VEST

(Illustration on page 44)

Knitted Back and Matching Calot

MATERIALS:

CHADWICK'S RED HEART SHETLAND FLOSS, 3 balls for sizes 12 and 14; 4 balls for sizes 16 and 18.

CLARK'S O.N.T. KNITTING PINS, 1 pair No. 3 for sizes 12 and 14; 1 pair No. 4 for sizes 16 and 18.

CLARK'S O.N.T. BONE SOCK NEEDLES, 1 set No. 3.

Steel crochet hook No. 2.

3 buttons of graduated sizes for top of calot.

VEST BACK . . . Cast on 78 sts. Work in ribbing of k 2, p 2 for 2 inches. Inc 1 st at both ends of next row and every 5th row thereafter until there are 98 sts. Work straight until piece measures same as side edge of fabric front.

To Shape Armholes: Bind off 4 sts at beginning of next 2 rows. Dec 1 st at both ends of every 5th row until 66 sts remain. Work straight until piece measures same as armhole depth of fabric front.

To Shape Shoulders: Bind off 6 sts at beginning of each row until 30 sts remain. Bind off for back of neck. With right side facing work a row

of s c along armhole, shoulder and back of neck edges. Fasten off.

Pin shoulder edges of fabric front and knitted back together and stitch ($\frac{1}{2}$ " seams) with sewing thread to match front. Sew underarm seams in same way. Press seams open.

CALOT . . . With double yarn cast on 93 sts. Divide sts among 3 needles. Join being careful not to twist sts. Work in rnds of ribbing of k 2, p 1 for 2 inches. Break off 1 strand of yarn. On next rnd inc in each p st (124 sts). Now work in ribbing of k 2, p 2 until piece measures $6\frac{1}{2}$ inches in all. **Next rnd:** Dec 1 st in each knit rib. Work in ribbing of p 2, k 1 until piece measures $7\frac{1}{2}$ inches in all. **Following rnd:** Dec 1 st in each purl rib. Work in ribbing of k 1, p 1 until piece measures 8 inches in all. **Next rnd:** K 2 together around. Break yarn leaving an 8-inch length. Thread a needle with this length and slip sts off needles onto it. Draw together tightly and fasten securely. Turn Calot, then turn up the 2 inch cuff having the k 2 rib of cuff on right side of Calot.

TRIM . . . Ch 2. **1st rnd:** 6 s c in 2nd ch from hook. Do not join rnds. **2nd rnd:** 2 s c in each st around. **3rd rnd:** * S c in next s c, 2 s c in next s c. Repeat from * around. Continue thus increasing 6 s c each rnd until piece covers surface of button. Work

1 rnd straight. Then dec every 3rd st until opening is closed—to dec work off 2 sts as 1 st. Fasten off. Cover other 2 buttons in same way. Sew one button on top of the other, then fasten to the top of the Calot.

Cutting Down Vest

Cut vest apart at shoulder and underarm seams. Fit front and back of vest to figure. Second button from bottom should be at waistline. Pin seams (directly on top of shoulders) so that waistline is in this position. Vest will extend away from figure at front armhole. Draw this excess down to underarm seam and make a dart into underarm seam. Pin dart. Take off vest. Mark shoulder seams and side seams on front of vest with bastings. Mark underarm darts in both vest and lining. Pin both fronts together. Cut off at shoulder and sides allowing 1" for seams.

Stitch darts in vest and lining separately. Slash darts in vest and press open.

Turn under $\frac{1}{2}$ " on vest and lining at shoulder and underarm seams, ripping back outside stitching where necessary. Baste edges together. Press. Stitch close to edge by machine. Make and attach knitted back as directions specify.

These garments and other wool articles for which directions are given in this book may be made from wool which has been reclaimed from discarded knitwear. Instructions for reclaiming such wool are given below.

HOW TO RECLAIM USED WOOL

Any knitted garment from which wool is being reclaimed must be washed and dried thoroughly and then unraveled. Do not try to unravel a sweater which is closely matted. Hand-knit sweaters are very easily ripped, for the wool winds off in one continuous motion. For a hand-knit sweater the process is as follows.

1. Wind the strand of wool which is being unraveled, around a bread board taking care that the end is visible. Continue until you have a sufficiently large skein. Then break off the wool.
2. Tie the starting and finishing ends of the raveled piece on the board together.
3. At 4 equal distances apart, tie a white thread around the strands of wool on the board.
4. Remove wool from bread board.
5. Repeat steps 1 to 4 until entire garment is unraveled.
6. Dip the raveled skein of wool into

warm water until thoroughly soaked.

7. Squeeze out excess water.
8. Tying a weight to the bottom of the wet skein to remove kinks, hang skein up to dry. Do not expose directly to the sun. An airy place is best.
9. When thoroughly dry, wind into balls. Now you are ready to knit.

On a machine-knit sweater with side seams it is not practical to unravel. This may be treated as regular fabric and cut up into small articles. The seam edges should be closely overcast, if this is done.

A machine-knit sweater without side seams may be unraveled. The process is as follows:

1. Cut off top part of sweater from beginning of armhole shaping, and begin to unravel from that point.
2. Pick up the top strand of wool which is being unraveled, and wind it around a bread board for one complete round. This strand, at the end of the round, will be

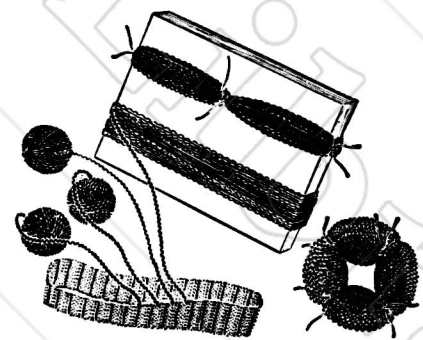

- 1 to 8 rounds down from top, depending on the number of strands.
3. Pick up the next strand, and wind it into a ball for one complete round. This strand, at the end of the round, will be directly under the end of the previous round.
4. Repeat step 3 as many more times as you have strands.
5. Repeat steps 2 to 4 inclusive until the lower section of sweater is completely unraveled.
6. Complete the operation by doing steps 2 to 9 on directions for hand-knit sweater. Each ball must be first wound around board into a skein.

Suggestions FOR EASY SEWING

CUTTING ON THE CORRECT GRAIN

"Grain" means the direction of the threads of a fabric. Therefore, "lengthwise grain" means the thread running the length of the fabric piece, parallel to the selvage or finished side edges of the piece. "Crosswise grain" is the thread running across the fabric from selvage to selvage. A piece is cut or torn from the bolt along the "crosswise grain." Marks on pattern pieces indicating "straight of goods" must be placed on the *lengthwise* grain of the fabric, that is, on a thread parallel to the selvage edge. This is the most important part of correct cutting since straight grains determine correct fit.

The lengthwise grain or thread is very firm while the crosswise grain has some stretch. The grains may be felt by taking a scrap of fabric and pulling with the grain both ways. The most stretch in any fabric is the true bias which is not a straight grain but which is a perfect diagonal across the fabric. To find the true bias, bring the lengthwise straight of goods (the selvage) to meet the crosswise grain. The fold is the true bias (Fig. 1).

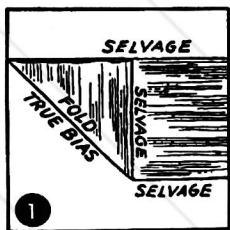

BASTING AND STITCHING A PLAIN SEAM

In the directions for making all items in the book, "stitch" means to do as follows:

1. Pin edges together right side to right side matching any notches. Place pins at right angles to edge about $1\frac{1}{2}$ " apart.
2. Baste a scant $\frac{1}{2}$ " from edge. Using a single, knotted thread and taking even stitches about $\frac{1}{2}$ " long.
3. Stitch by machine $\frac{1}{2}$ " from edge (Fig. 2).
4. Remove basting by clipping at short intervals so that it does not draw fabric.
5. Press seam open (unless directions specify differently).

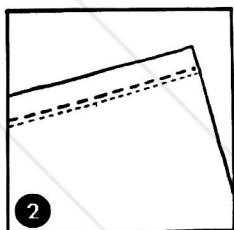

SEAMS

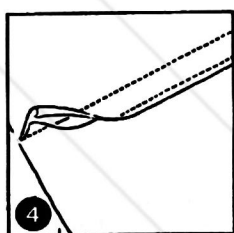
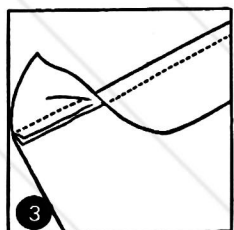

1. **French Seam . . .** A seam used on lightweight fabrics for infants' and children's clothes. Baste wrong sides of garment together. Stitch $\frac{1}{4}$ " nearer edge than indicated seam line. Trim seam to $\frac{1}{8}$ ". Turn to wrong side. Fold on seam line. Baste $\frac{1}{8}$ " from fold edge. Stitch $\frac{1}{4}$ " from edge by hand or machine (Fig. 3).
2. **Flat Fell Seam . . .** A strong tailored seam for blouses, children's clothes, pajamas. Baste wrong sides of garment together. Stitch along seam line. Press seam towards back of garment (armhole seams into

sleeve). Trim under side of seam allowance to $\frac{1}{8}$ ". Turn under edge of upper seam allowance so that seam is $\frac{1}{4}$ " wide. Baste down over trimmed seam. Stitch close to edge by machine (Fig. 4).

3. **Top Stitched Seam . . .** A seam made from right side, for applying yokes, etc. Fold, baste, and press seam allowance under on one piece. Baste fold edge against seam line on second piece. Stitch from right side close to fold edge (Fig. 5).

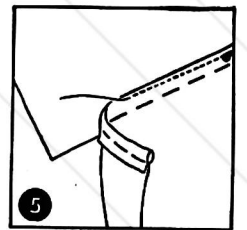

SEAM FINISHES

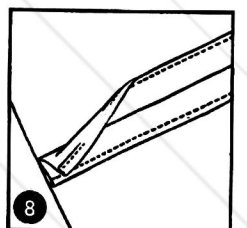
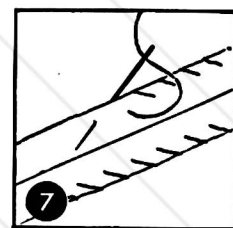
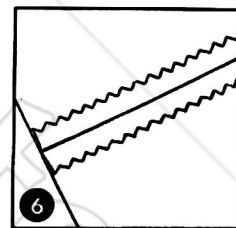

1. **Pinking . . .** A finish for fabrics which will not fray. Trim edges with pinking shears being careful not to cut into fabric (Fig. 6).
2. **Overcasting . . .** Make firm, short, slanting stitches close together over edges (Fig. 7).
3. **Machine Back Stitch . . .** Fold raw edge back $\frac{1}{8}$ " to $\frac{1}{4}$ " and stitch close to fold by machine (Fig. 8).

GATHERING

To machine gather, adjust machine stitch to 6 or 8 stitches to the inch. Run two rows of stitching along the edge to be gathered, one row on $\frac{1}{2}$ " seam line and the other $\frac{1}{4}$ " from edge. Pull stitching up to proper measurement by pulling under (bobbin) threads of both rows at the same time. Pull top threads through to wrong side and knot both thread ends together to hold gathers in place. Distribute gathers evenly. When stitching gathered piece to another, stitch along $\frac{1}{2}$ " gathering line (Fig. 9).

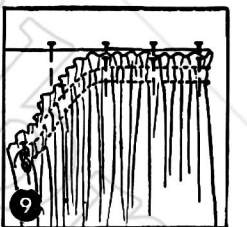

USEFUL STITCHES

1. **Back Stitch . . .** A firm hand stitch. Take a small stitch. Take a second stitch back over first one bringing needle to right side of fabric the length of stitch ahead of first stitch (Fig. 10).
2. **Blind Hem Stitch . . .** A strong hem, invisible from right side. Slide needle under fold. Push it through and pick up one thread directly underneath, making a straight stitch at right angles to hem edge (Fig. 11).

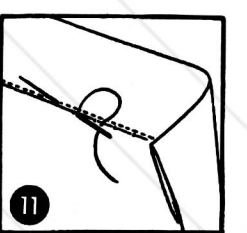
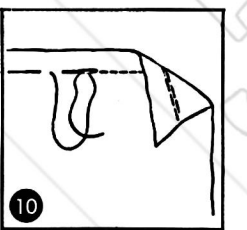

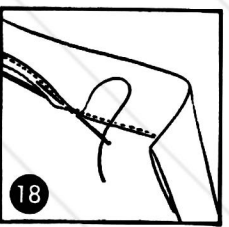
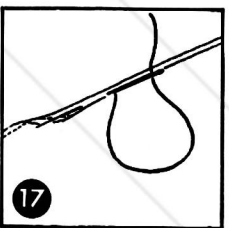
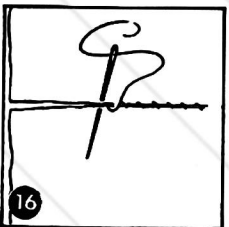
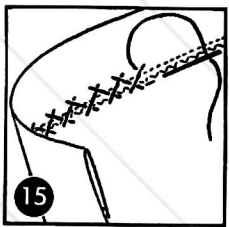
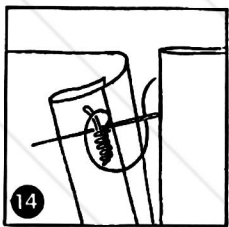
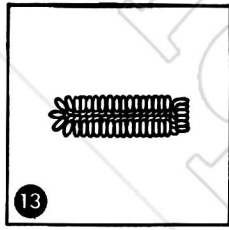
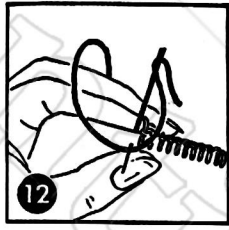

3. **Buttonhole Stitch . . .** A firm reinforcement for edges. Thread needle with a double thread. Hold edge over forefinger. Take a few running stitches to the left of starting point, to anchor thread. (These will be covered with buttonhole stitches.) Bring needle through from wrong side at desired depth. Hold thread near fabric back over forefinger (with middle finger). Draw thread on needle to right and then left under needle. Loop is brought to raw edge when stitch is pulled up (Fig. 12). To make *Buttonholes*, make small running stitches close around buttonhole marking through both fabric and facing. Slash along marking. Finish raw edges with Buttonhole Stitches made close together (Fig. 13). To make *Thread Loops*, make loop to fit button from several strands of thread. Buttonhole Stitch closely together around these threads (Fig. 14).

4. **Catch Stitch . . .** A hem, invisible from right side, for heavy fabrics.—skirts, coats. Work from left to right. Take up a few threads of fabric, being careful not to have stitches show on right side. Take a similar stitch in hem about $\frac{1}{2}$ " to the right. Continue stitch, making zig-zag as shown (Fig. 15).

5. **Overhand or Whip Stitch . . .** A firm invisible method of joining two edges. Place edges together. Take small over and over stitches, close together, through both thicknesses (Fig. 16).

6. **Roll Hem Stitch . . .** A narrow hem for lightweight fabrics. Machine stitch close to edge of material. Trim close. Roll edge between thumb and forefinger and slip stitch (Fig. 18). Finished hem should be less than $\frac{1}{8}$ " wide (Fig. 17).

7. **Slip Stitch . . .** A hem, invisible from both sides, for dresses, skirts. Insert needle on fold, slip it along about $\frac{1}{4}$ " or more and bring it through. Take up 1 to 3 threads of fabric directly under point where needle comes through, draw thread through and begin next stitch (Fig. 18).

(toward raw edge of bias strip). Fold raw edge in $\frac{1}{4}$ " (to meet raw edges of seam). Slip stitch (Fig. 18) fold edge to seam on wrong side (Fig. 19).

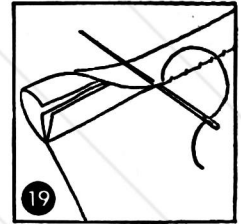

PRESSING

Success or failure in making a garment often depends on the way it is pressed during the making as well as after completion.

General Suggestions . . .

1. Have two pressing cloths, one of muslin, one of drill cloth. Remove all sizing by washing well before using.
2. Always test temperature of iron on scrap of fabric before pressing.
3. Press seams immediately after stitching. Do not wait until dress is completed.
4. Never rest iron on fabric. Keep it moving constantly to avoid marking fabric.
5. Press all seams up from bottom or in towards center of garment.
6. Press darts on light fabrics to one side, either up or towards center. On heavy fabrics slash darts and press open.
7. Lift gathers while working point of iron into them.
8. While pressing, always smooth garment into correct shape so that fabric is not stretched. Continue smoothing fabric before passing iron over it to avoid pressing creases into it.
9. Follow these suggestions in pressing:
 - a. **Cotton . . .** Turn garment to right side, sponge lightly and press with moderately hot iron. If sheen appears on test scrap use damp muslin pressing cloth.
 - b. **Linen . . .** Turn garment to wrong side, sponge lightly and press with moderately hot iron.
 - c. **Rayon and Silk . . .** Turn garment to wrong side and press with moderately warm iron. When moisture in pressing is necessary first cover garment with a dry drill cloth. Then place a damp muslin cloth on top. The steam will penetrate drill cloth without leaving a sheen on fabric.
 - d. **Wool . . .** Turn garment to wrong side and cover with a damp muslin pressing cloth. Press with moderate iron until cloth is almost dry. This steams fabric. Replace damp cloth with dry cloth. Continue pressing until almost dry. Pressing woolen garments until they are completely dry gives a sheen to garment. To prevent seam marks on right side of fabric, slip narrow strip of cardboard between seam and garment while pressing.

CUTTING AND APPLYING A BIAS BINDING

Bring lengthwise straight of goods to meet crosswise (see p. 48). Pin. Press fold. This fold is the *true bias*. Cut along fold and cut bias strips 1" wide from this edge. (Prepared Bias Trim may be purchased already cut and folded). Stitch bias strip to raw edge $\frac{1}{4}$ " from edge. Press seam up

SUPPLIES to MAKE and MEND

Needle Sizes and Correct Threads

FOR GENERAL SEWING: Sharps — medium length, small rounded eyes; Betweens — short length for short fine stitches.

FOR DARNING: Cotton Darners — extra long, long eyes to hold several strands of thread; Yarn Darners — extra coarse, heavy darners for sweaters, wool socks, blankets.

MILWARD'S SEWING NEEDLES, assortment of sizes 3 to 9 takes care of ordinary requirements.

Sewing Needle Size	Type of Fabric	Thread Size	Machine Needles	Machine Stitch per inch
Coarsest (3)	Heavy duck, canvas, coating.	8, 10, 12 Black and White	Coarsest	8
Coarse (4, 5)	Ticking, denim, sewing buttons on heavy material.	16, 20, 24 Black and White	Coarse	10, 12
Medium Coarse (6)	Cretonne, slip covers, wools, sewing buttons on medium-heavy material.	30, 36, 40 Black and White. Heavy Duty Mercerized Thread in colors.	Medium Coarse	12
Medium (7)	Percalle, gingham, rayon, linen, lightweight wool.	50, 60, 70 Black and White. Mercerized in colors.	Medium	14
Medium Fine (8)	Voile, lawn.	80, Black and White. Mercerized in colors.	Medium Fine	16, 18
Fine (9)	Organdie, Batiste.	100, Black and White. Mercerized in colors.	Fine	20, 22

Threads for Hand and Machine Sewing

Best 6-Cord Sewing Threads CLARK'S O.N.T. or J. & P. COATS	Black and White Size 8, 10, 12, 16, 20, 24, 30, 36, 40, 50, 60, 70, 80, 100.	For general machine and hand sewing. Coarser or finer sizes according to fabric.
Mercerized Sewing CLARK'S O.N.T. or J. & P. COATS	Size 50. Black, White and colors.	For general machine and hand sewing on colored fabric of cotton, silk, rayon, wool or linen.
Heavy Duty J. & P. COATS	Black, White and colors.	For sewing heavier fabrics, especially slip covers, draperies, for sewing on buttons, for heavy wools.
Button & Carpet CLARK'S O.N.T.	Extra strong, Black, White and colors.	For sewing extra heavy fabrics and for sewing on buttons.

Bias Trim

Percalle and Fine Lawn J. & P. COATS	Single and double fold. Black, white, colors. *Boilfast.	For binding, finishing and trimming.
-----------------------------------------	----------------------------------------------------------	--------------------------------------

Darning and Mending Threads

Mercerized Darning CLARK'S O.N.T. or J. & P. COATS	All threads matched to fashionable and popular hosiery. Also compact, convenient assortments in packages.	For silk, nylon, rayon, or lisle hosiery.
Plain Darning CLARK'S O.N.T. or J. & P. COATS		For cotton hosiery.
Mending Wool CHADWICK'S		For wool hosiery and sweaters.

Crochet, Tatting and Embroidery Threads

CLARK'S O.N.T. and J. & P. COATS threads come in a wide assortment of sizes and colors, suitable for fashion and household articles. Boilfast* colors.

Wools

CHADWICK'S RED HEART WOOLS are made for every purpose.

ABBREVIATIONS in CROCHET and KNITTING

ch chain	sl st slip stitch	incl inclusive
sc single crochet	pc st popcorn stitch	inc increase
dc double crochet	sp space	dec decrease
hd c half double crochet	st stitch	k knit
tr treble	sts stitches	p purl
d tr double treble	rnd round	tog together
tr tr triple treble		p.s.o. pass slip st over k st

*(asterisk) Repeat the instructions following the asterisk as many more times as specified.

Note: Sometimes instead of an asterisk you will see a phrase like (k 2 tog, k 2) 5 times. This means that whatever is included in the parenthesis should be repeated the number of times specified directly after the closed parenthesis.



★ MAKE *and* ★ MEND ★

FOR VICTORY ★ BOOK NO. S-10 ★ PRICE 10 CENTS

