

Musterbuch

enthaltend

Einfache

Schmiede-Arbeiten

Zum Gebrauche

für

Stadt und Land.

Herausgegeben von

J. Feller in Düsseldorf.



Ravensburg.

Verlag von Otto Maier.

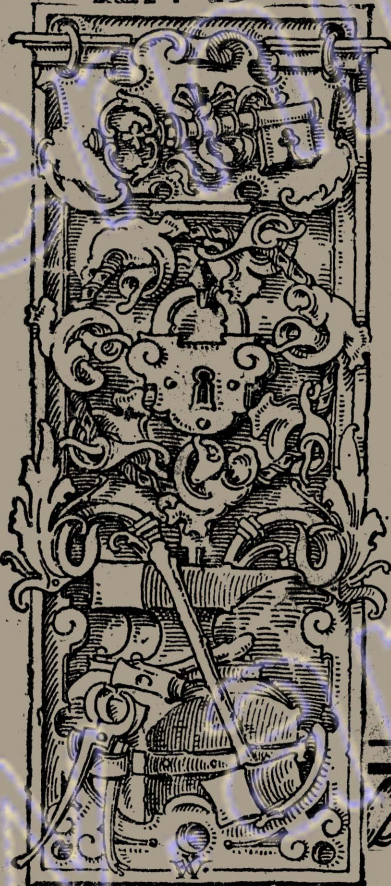

# EINFACHE SCHMIEDE-ARBEITEN FÜR STADT UND LAND.

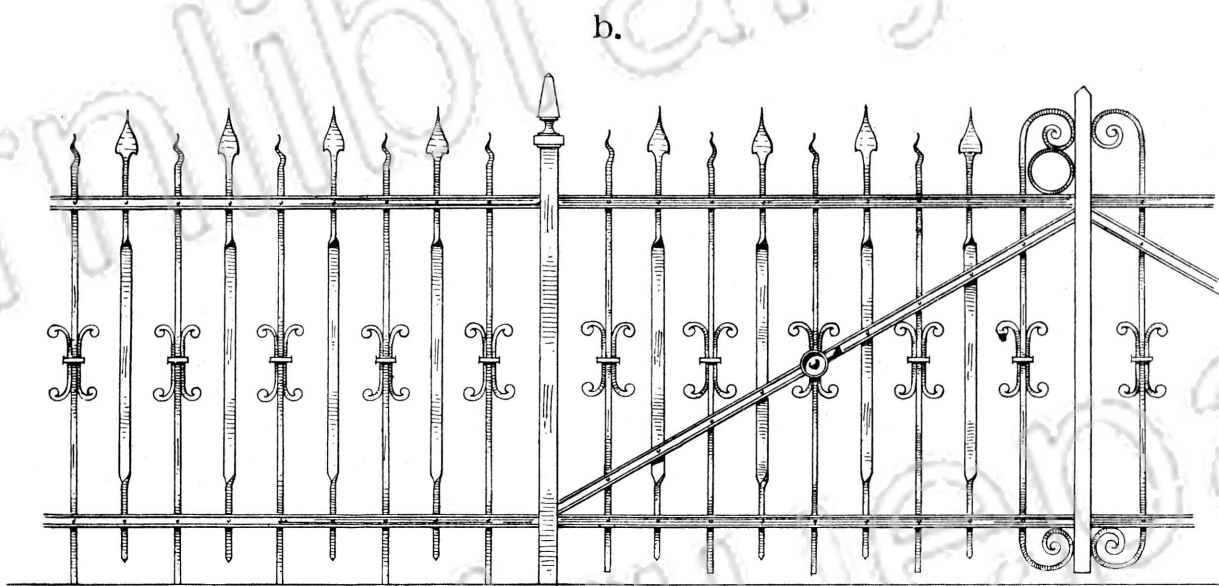
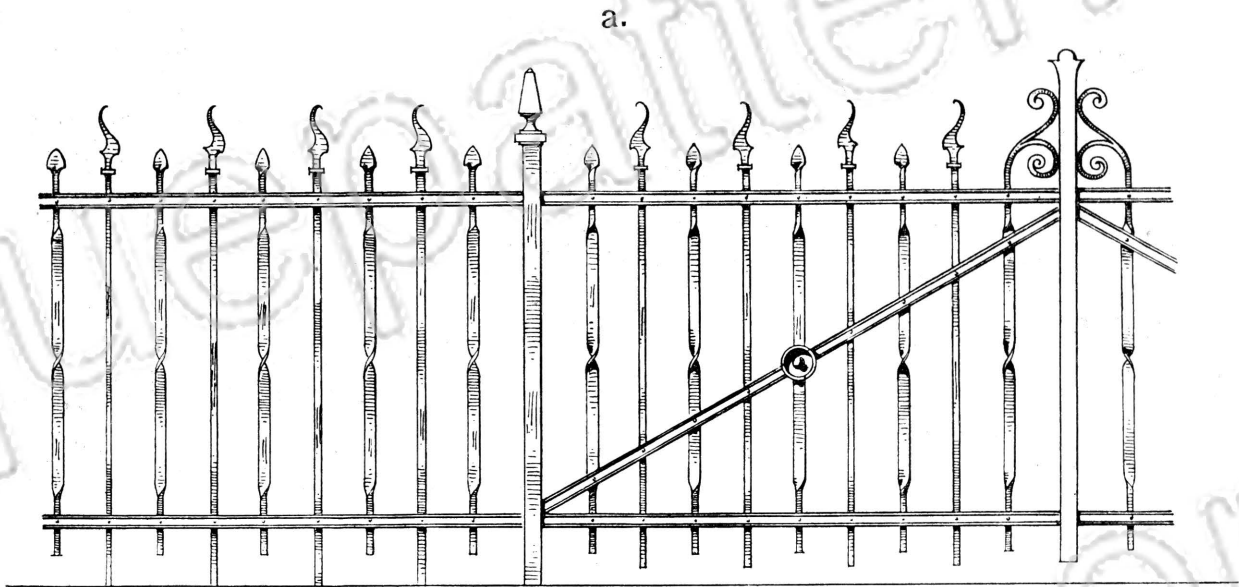

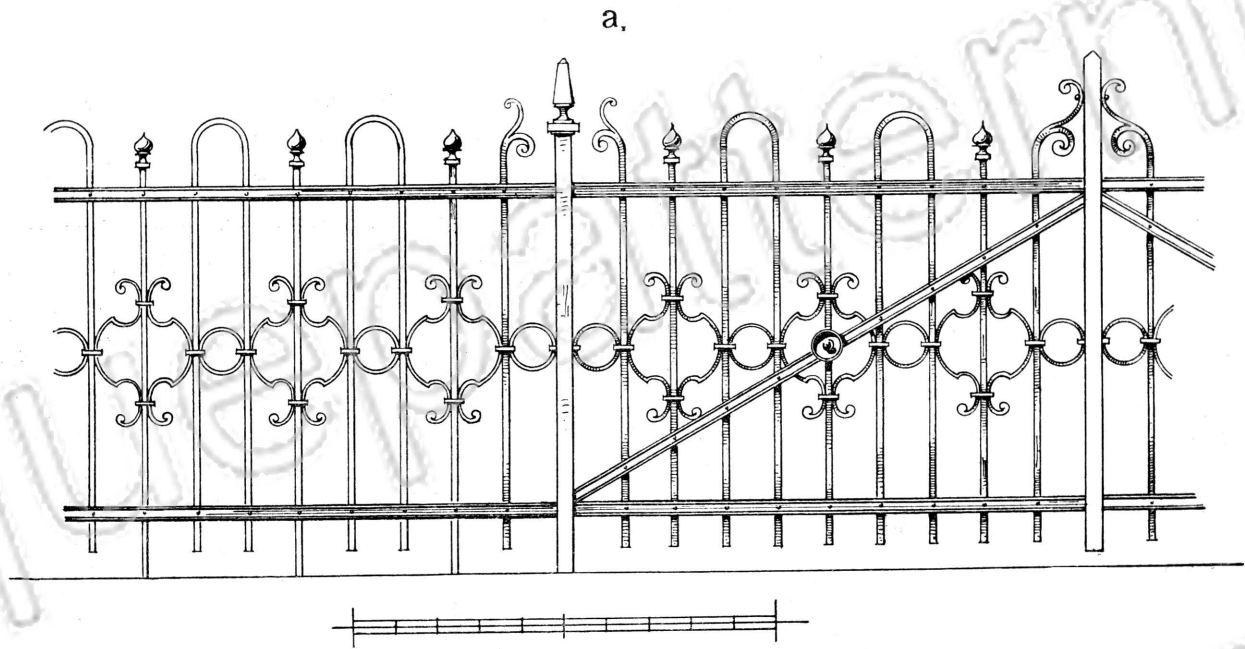

# EINFACHE SCHMIEDE-ARBEITEN FÜR STADT UND LAND.

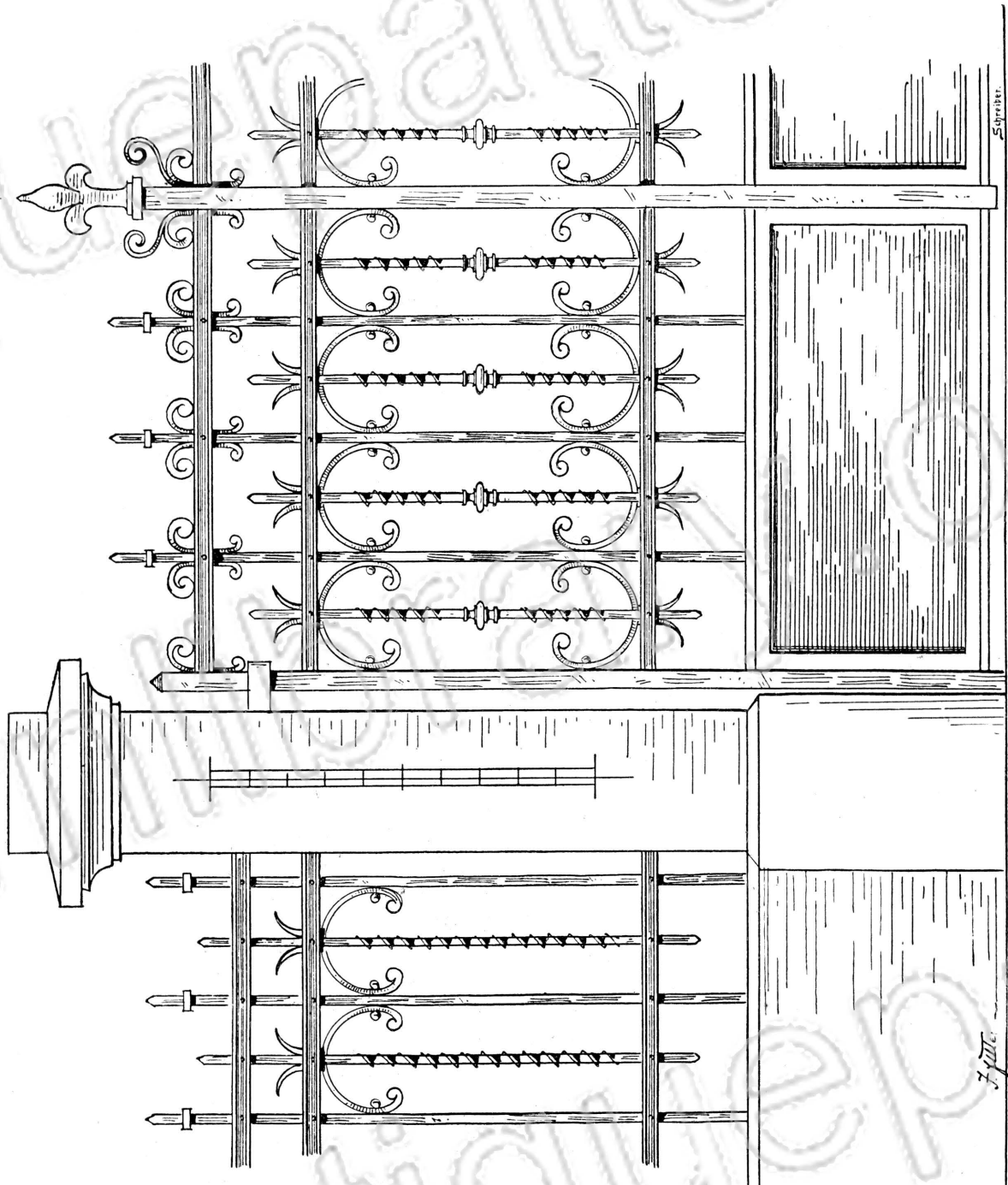

EINFACHE SCHMIEDE-ARBEITEN FÜR STADT UND LÄND.

a.

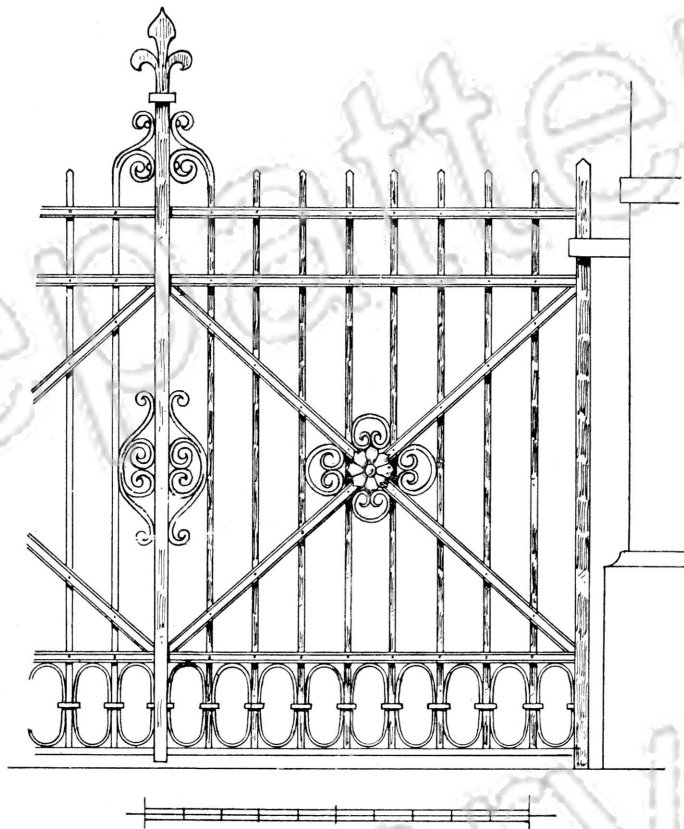

b.

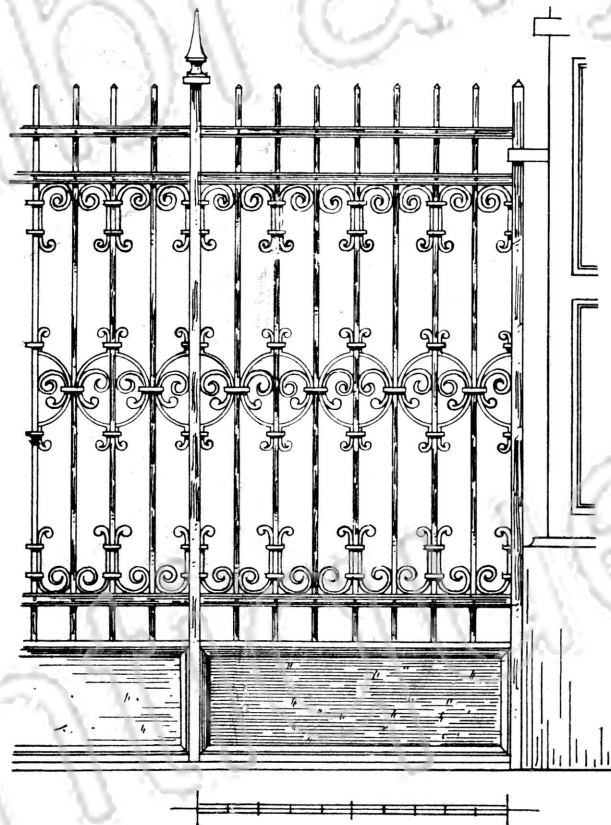

# EINFACHE SCHMIEDE-ARBEITEN FÜR STADT UND LAND.

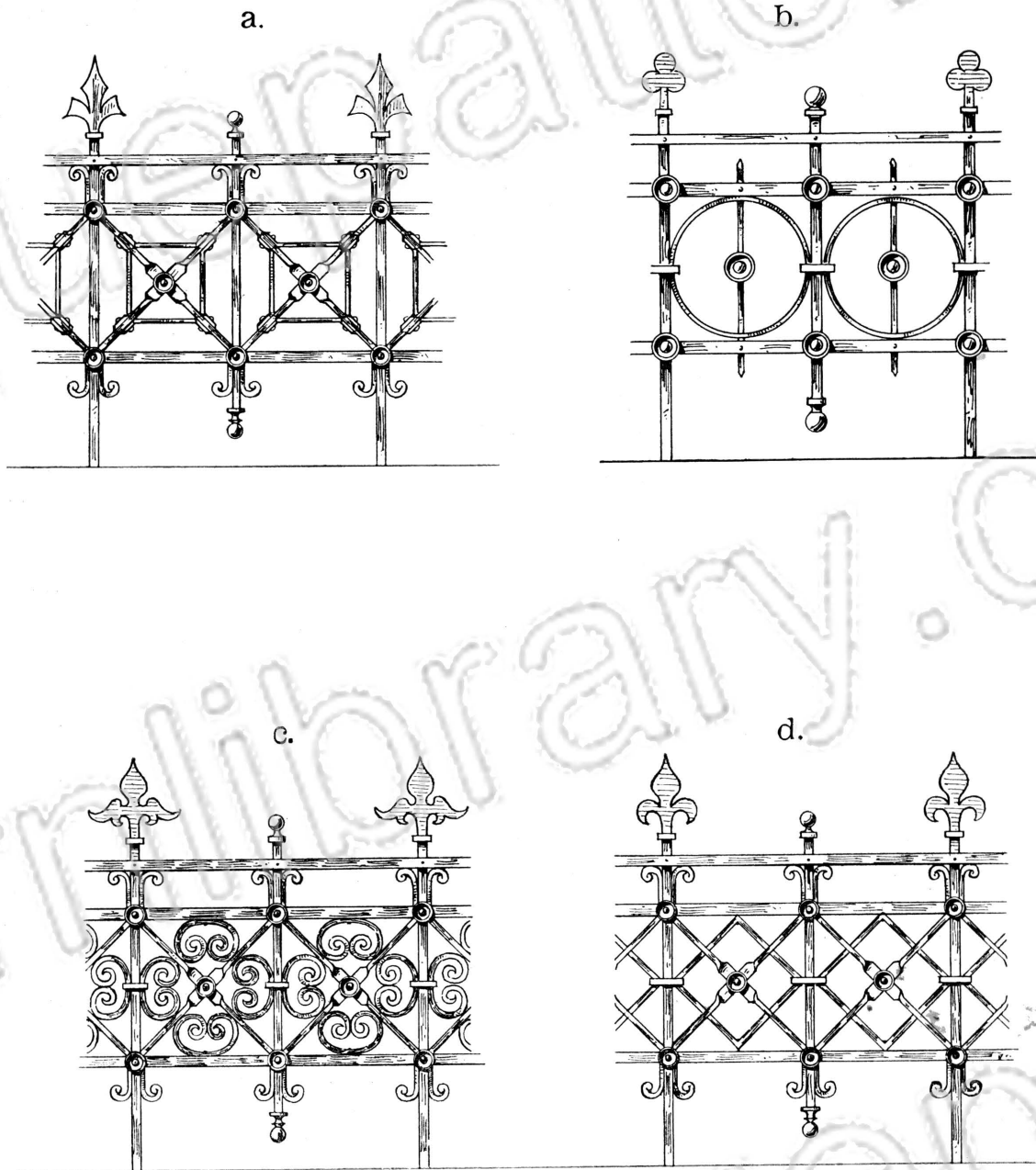

# EINFACHE SCHMIEDE-ARBEITEN FÜR STADT UND LAND.

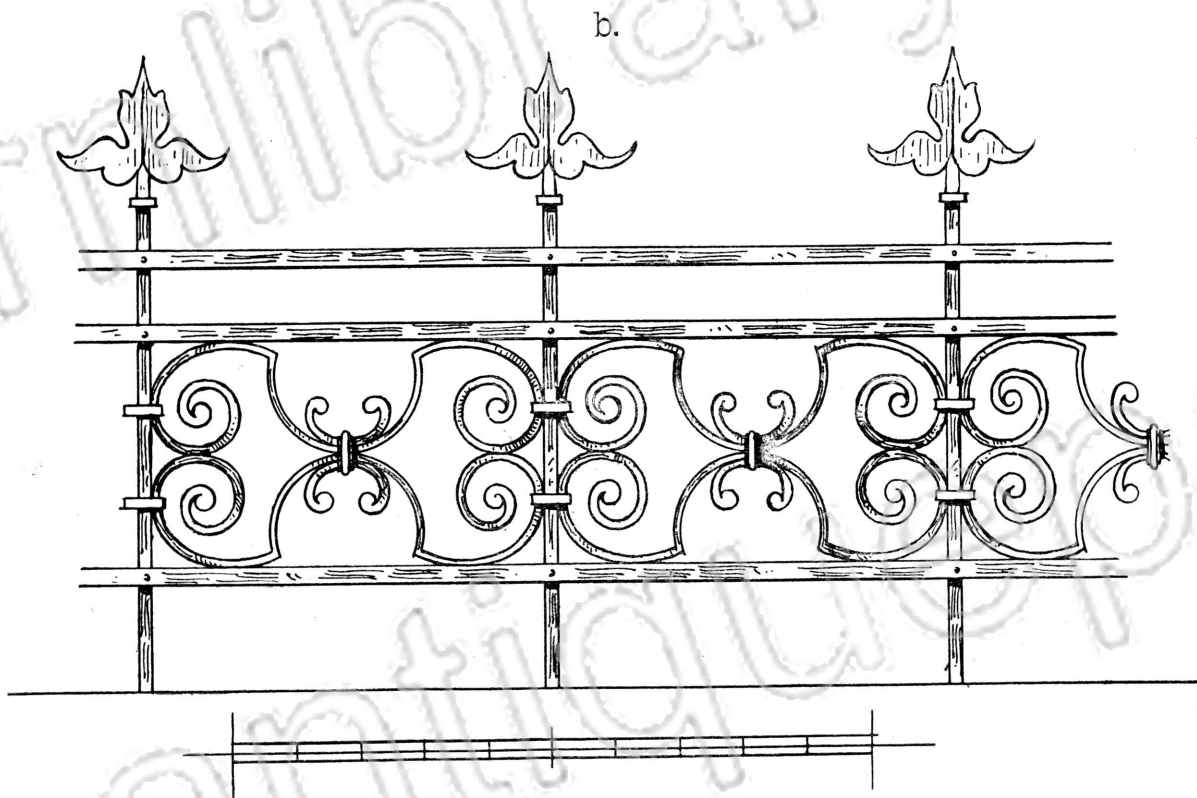
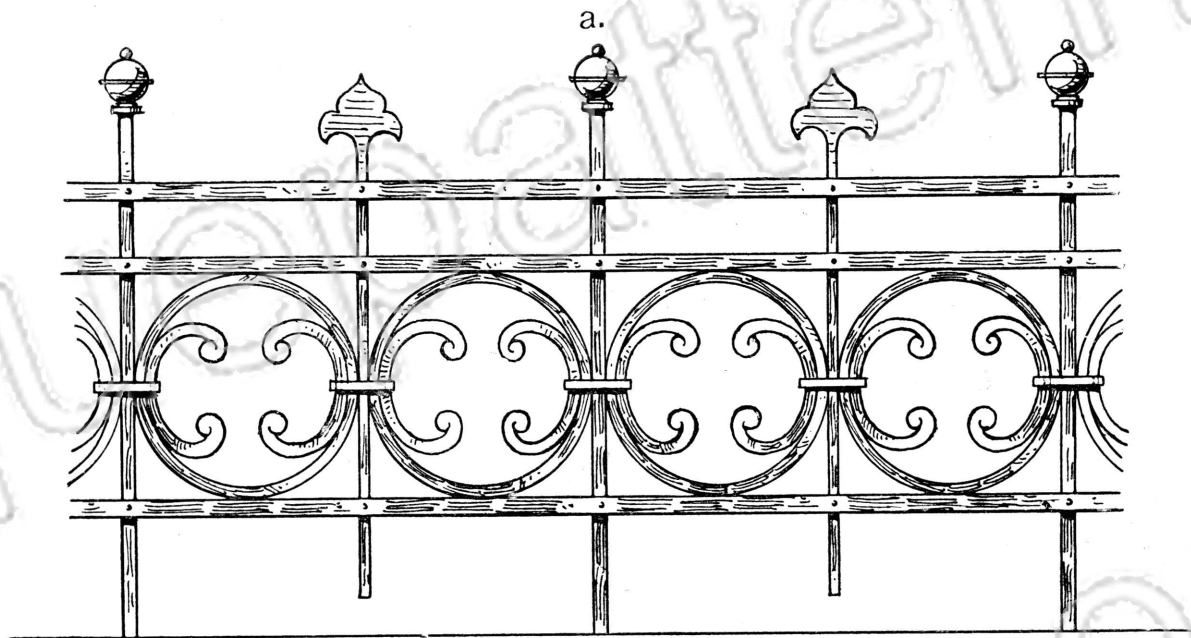

a.

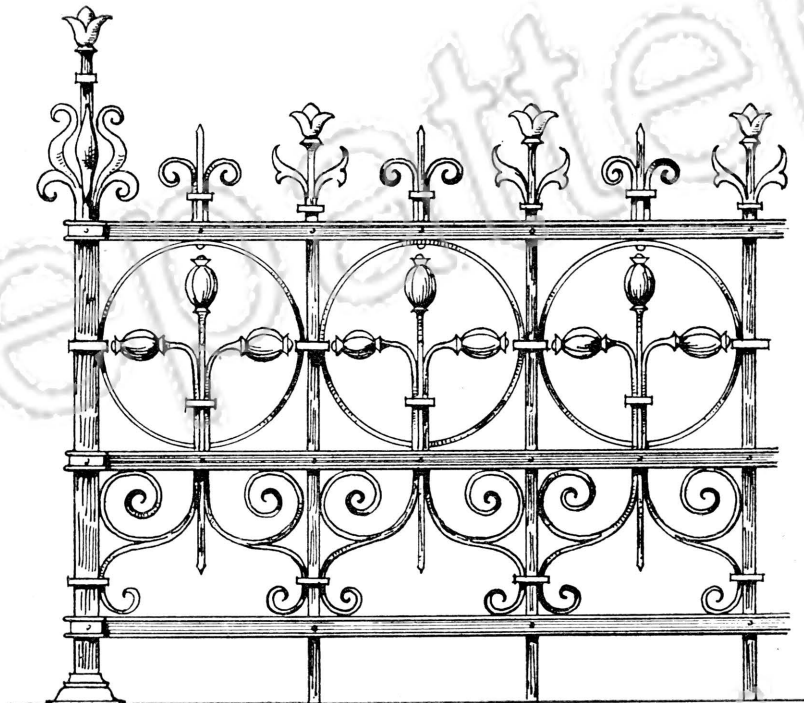

b.

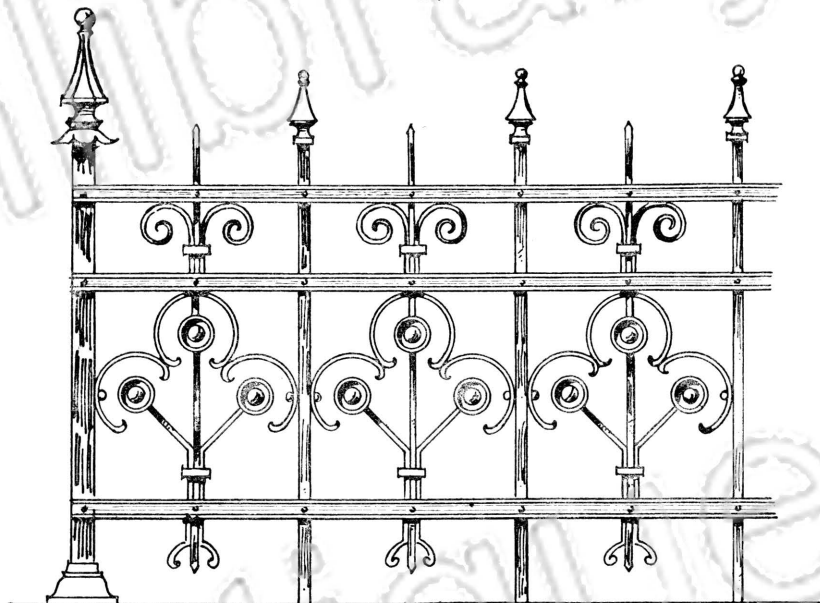

Masstab gilt für a und b.



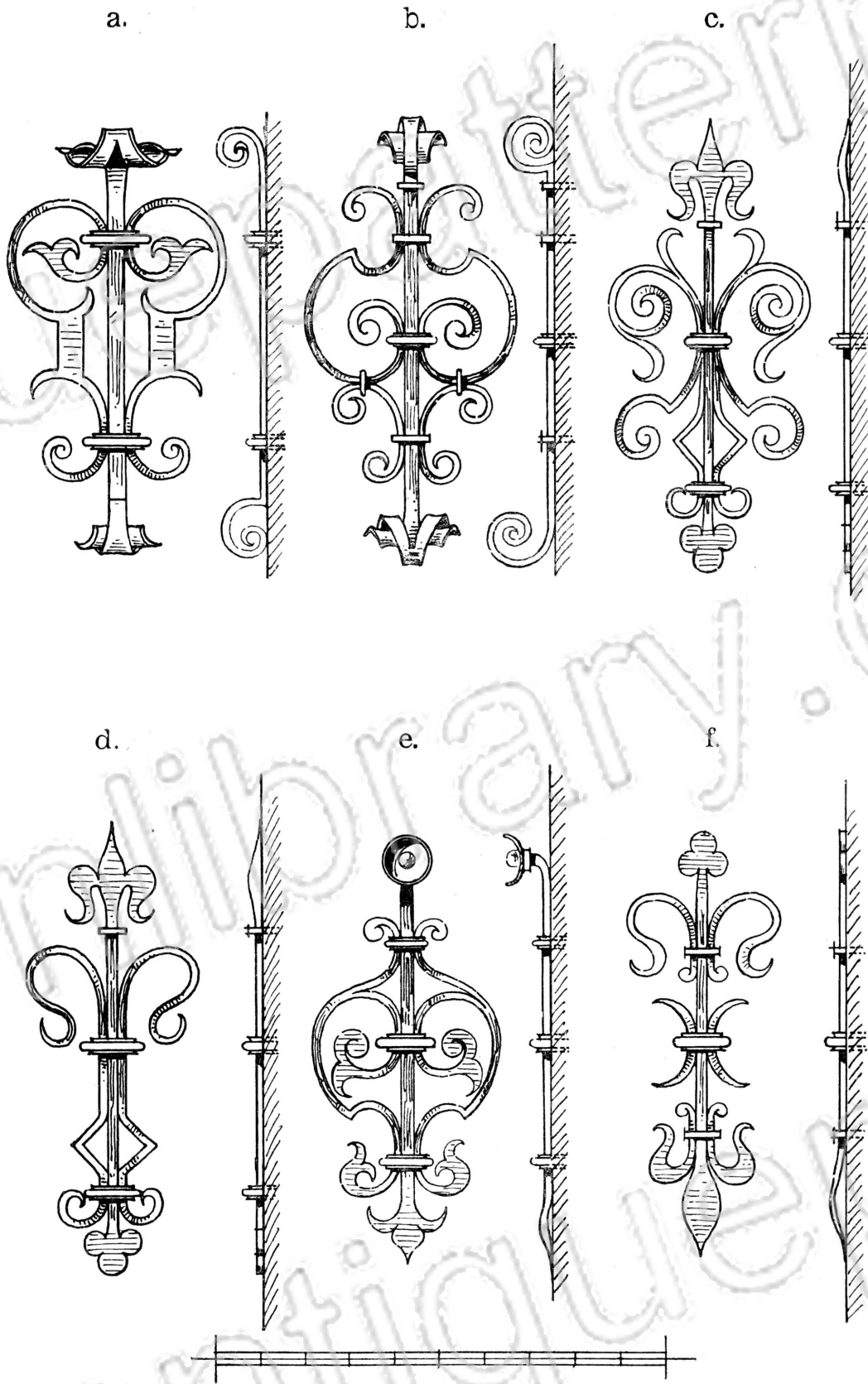

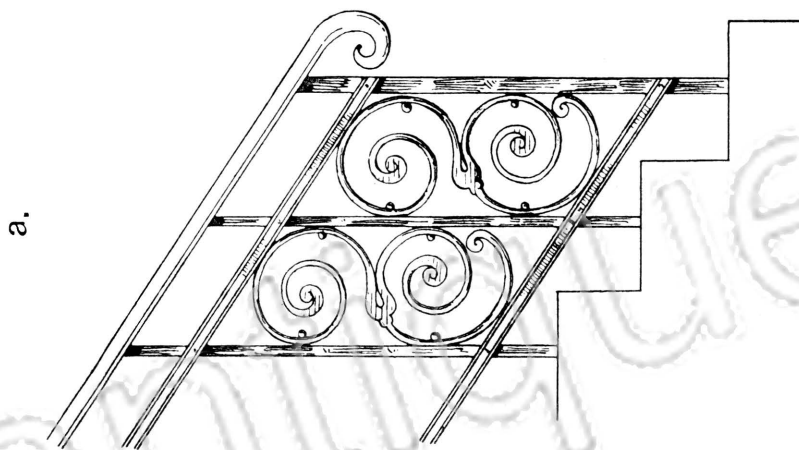
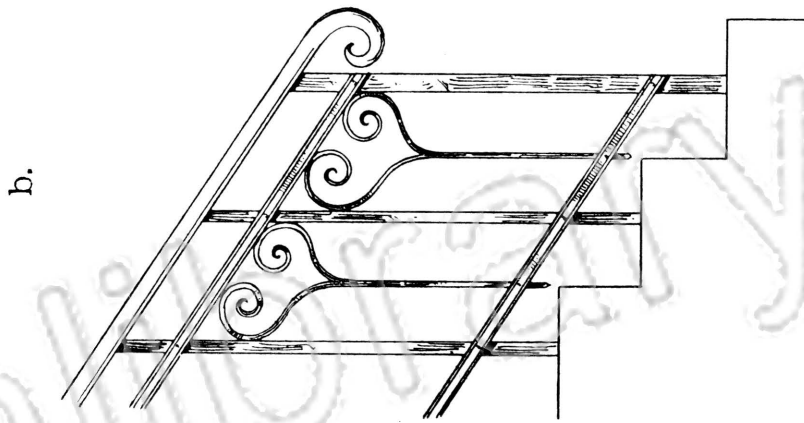
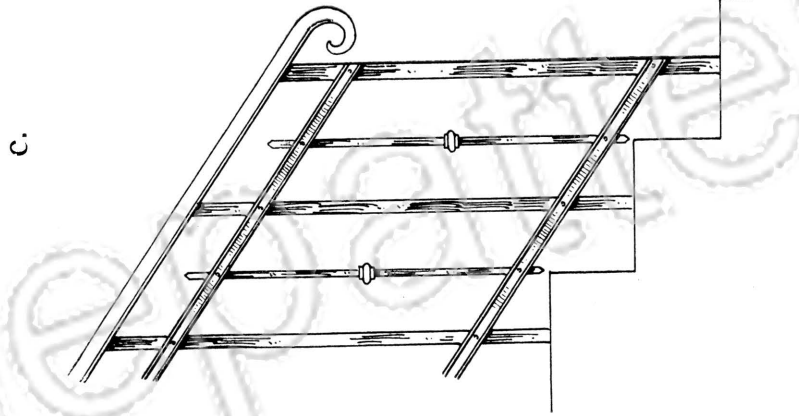

# EINFACHE SCHMIEDE-ARBEITEN FÜR STADT UND LAND.

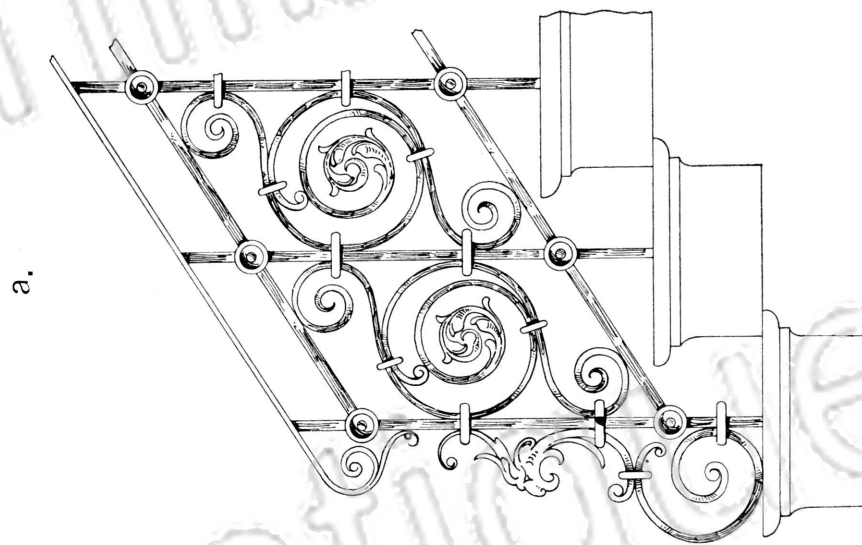
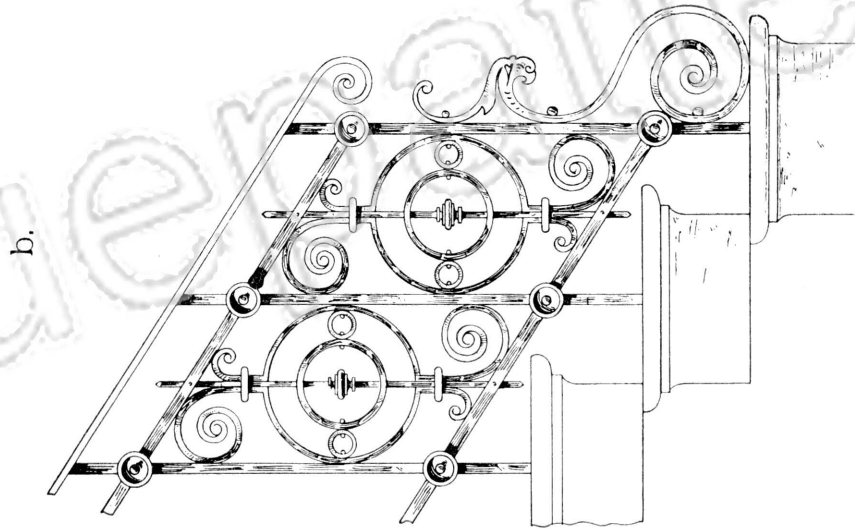

EINFACHE SCHMIEDE-ARBEITEN FÜR STADT UND LÄND.



EINFACHE SCHMIEDE-ARBEITEN FÜR STADT UND LAND.

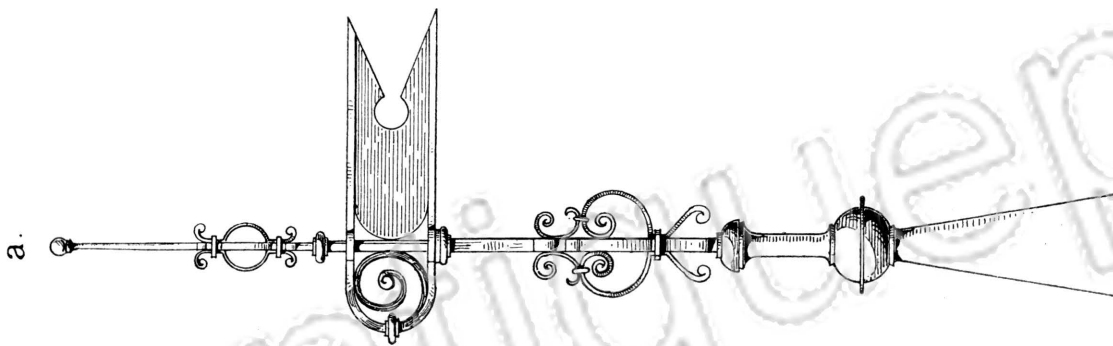
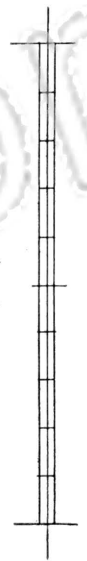
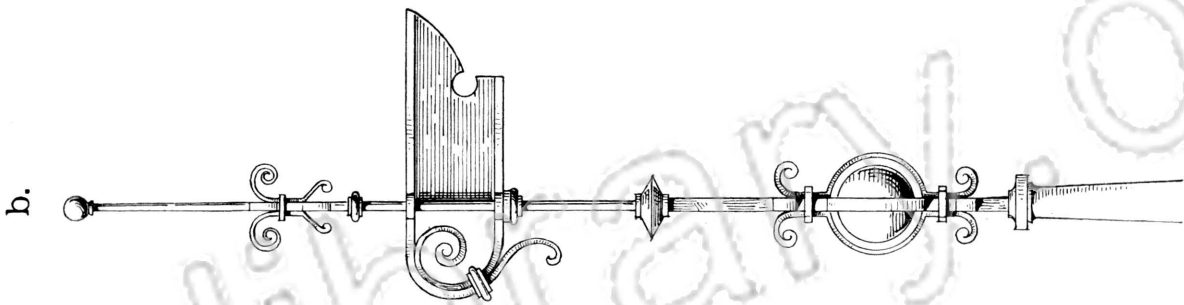
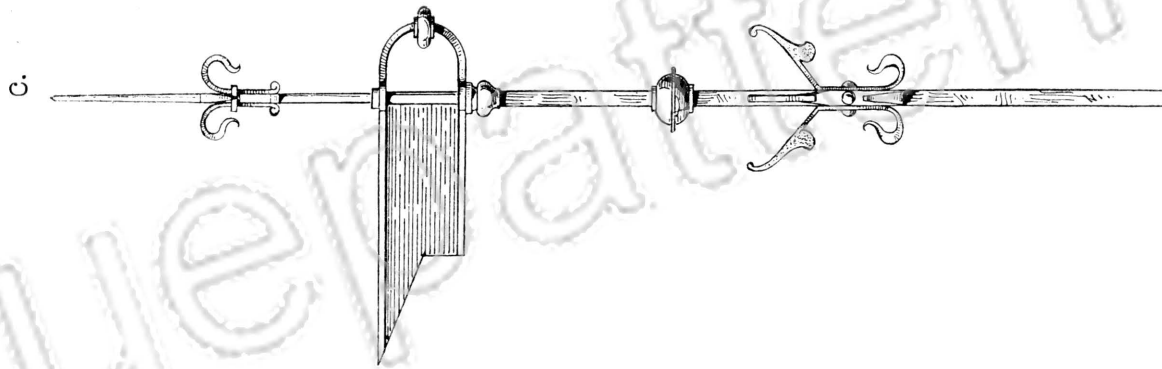

# EINFACHE SCHMIEDE-ARBEITEN FÜR STADT UND LAND.

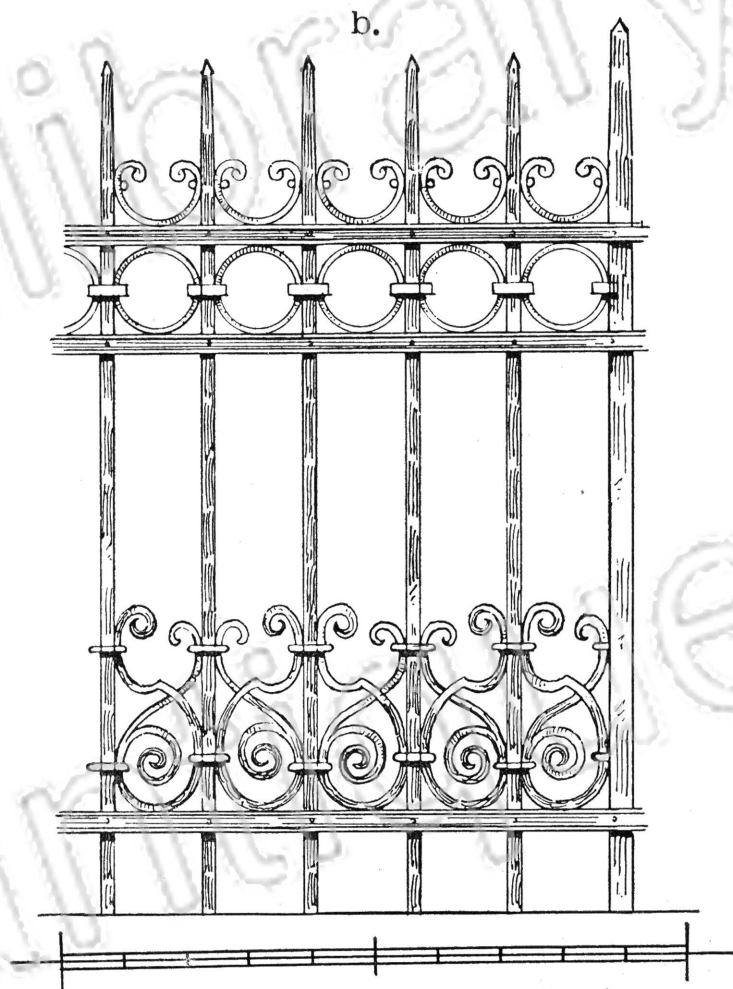
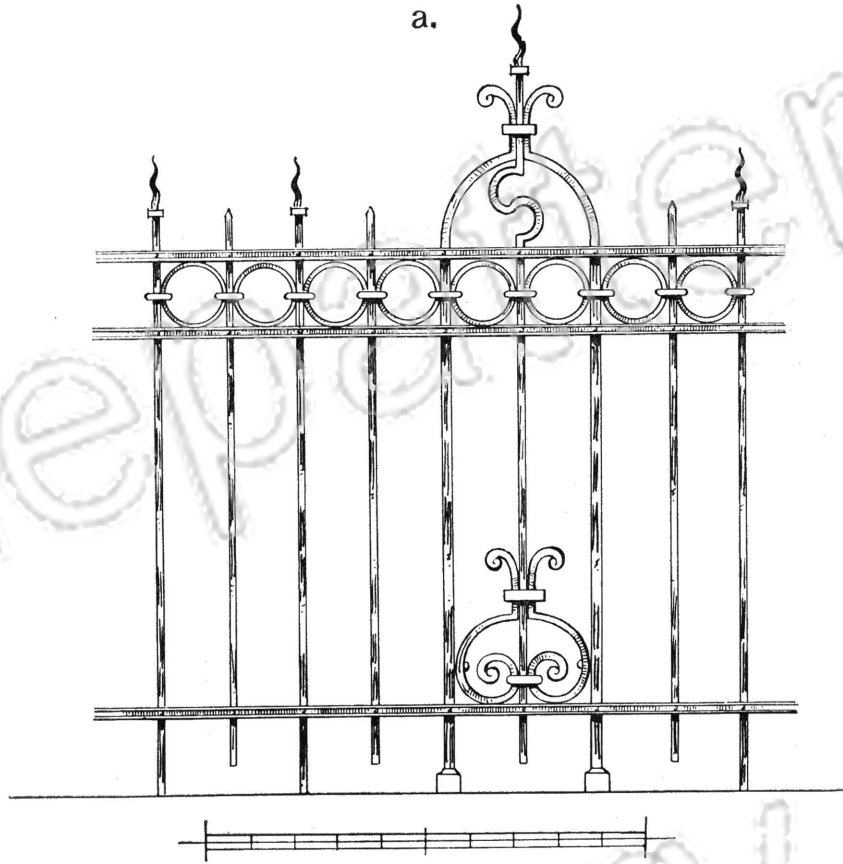

EINFACHE SCHMIEDE-ARBEITEN FÜR STADT UND LAND.

a.

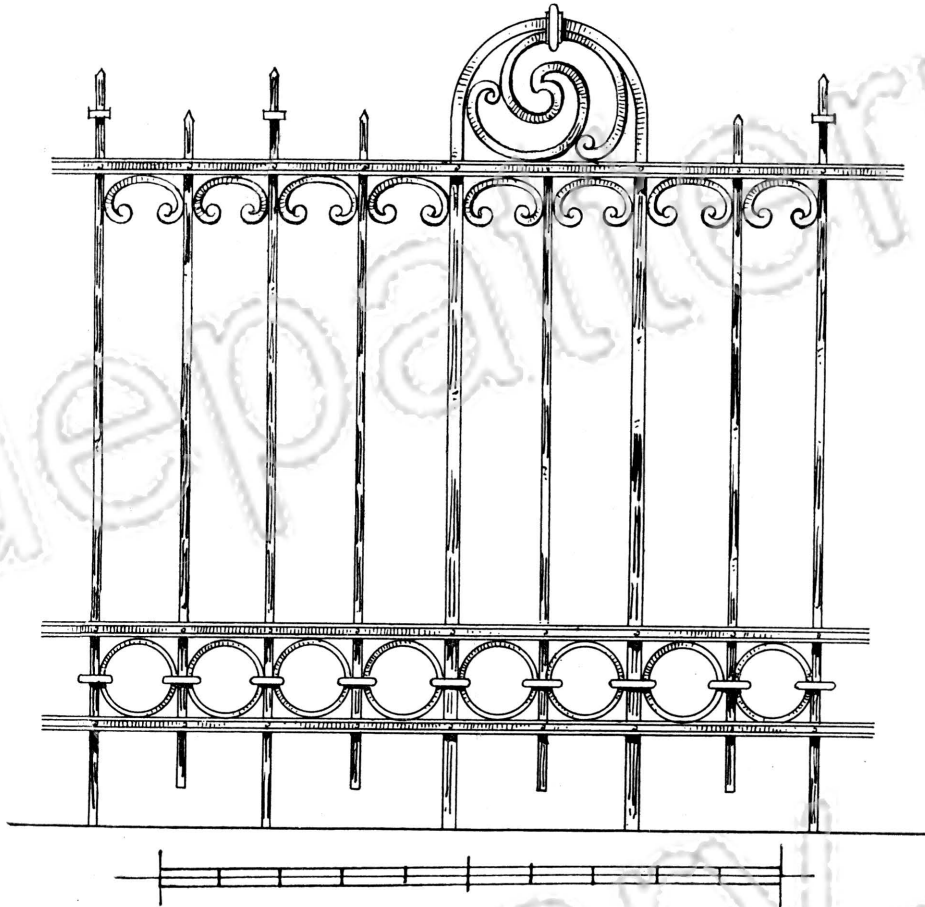

b.



EINFACHE SCHMIEDE-ARBEITEN FÜR STADT UND LAND.

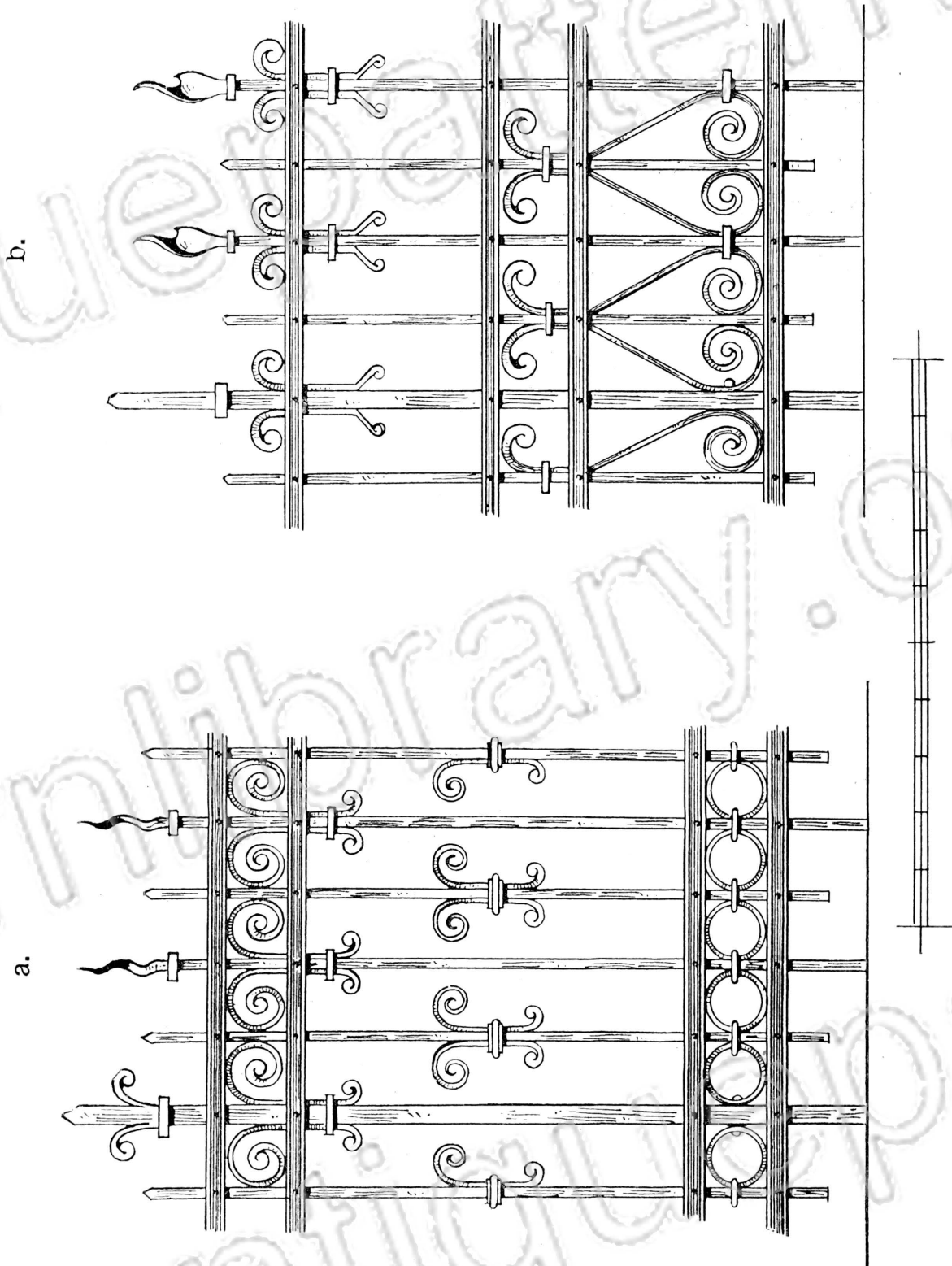



EINFACHE SCHMIEDE-ARBEITEN FÜR STADT UND LÄND.

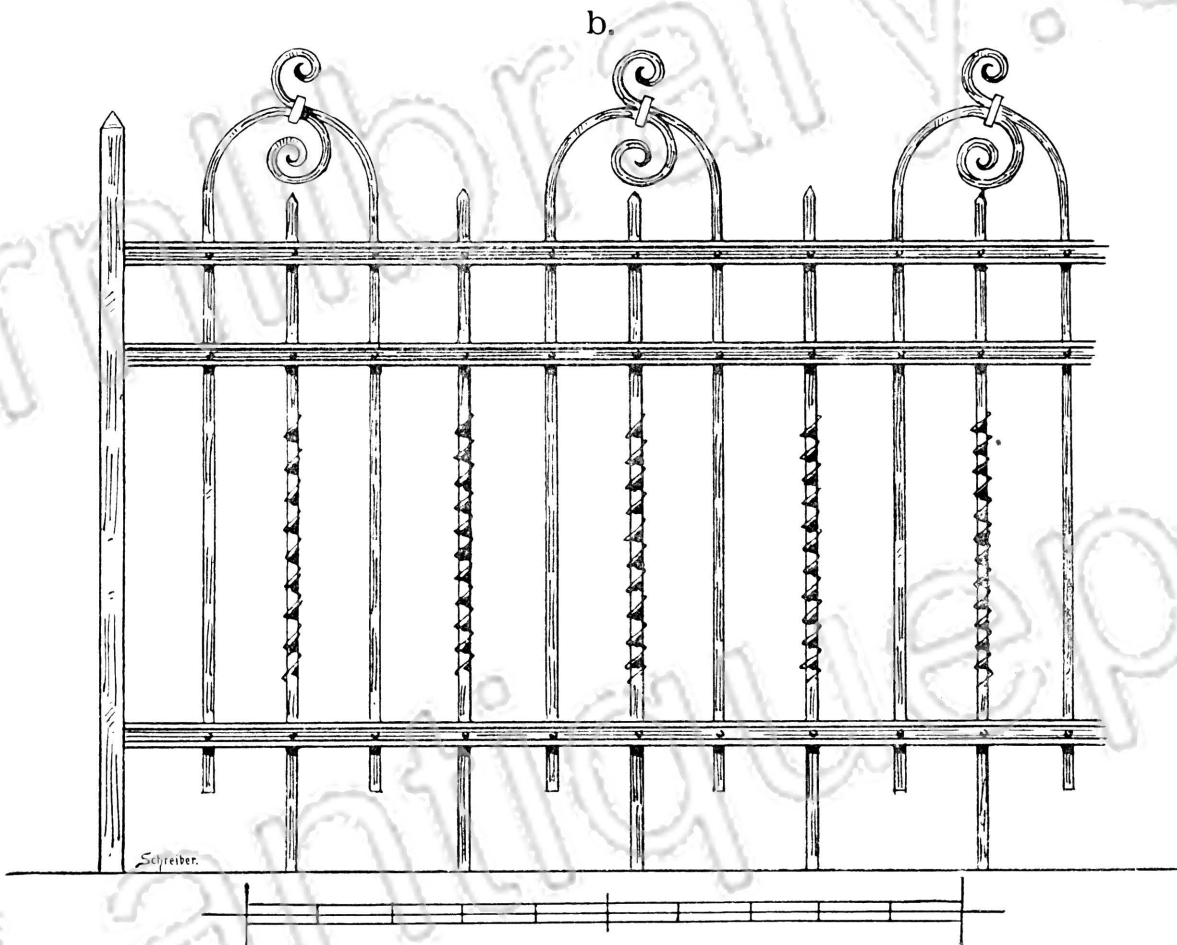
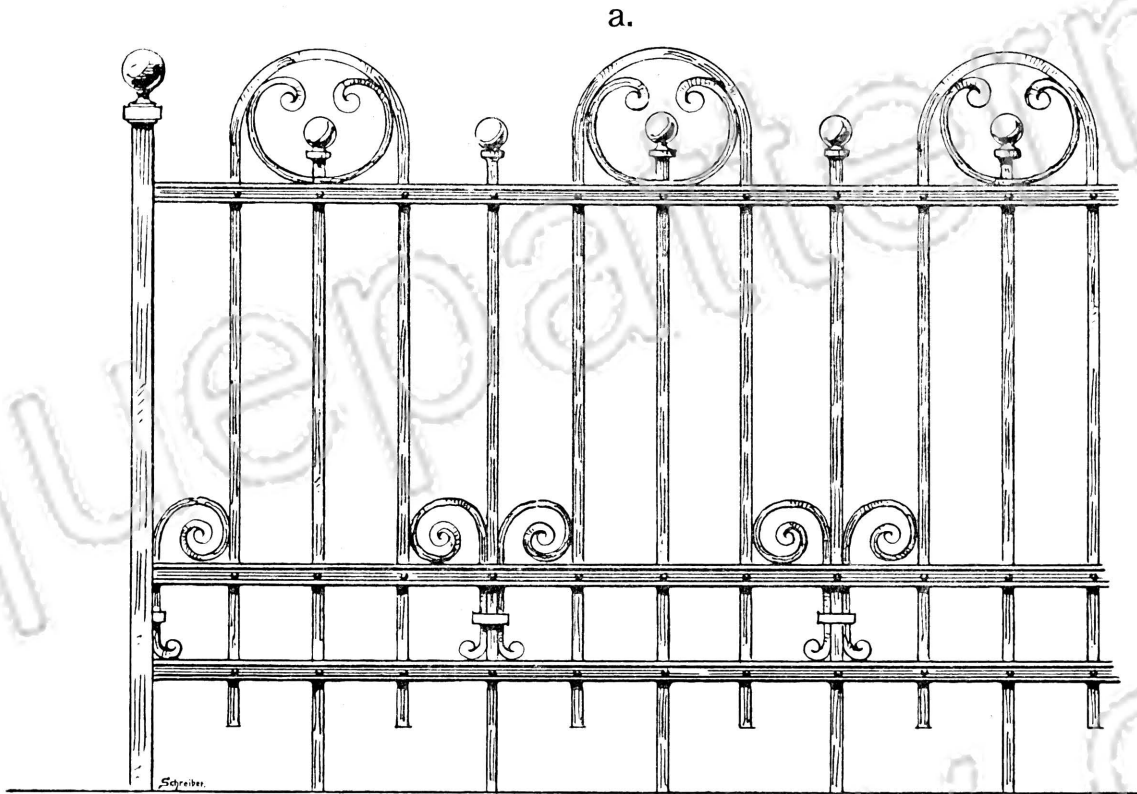

EINFACHE SCHMIEDE-ARBEITEN FÜR STADT UND LAND.

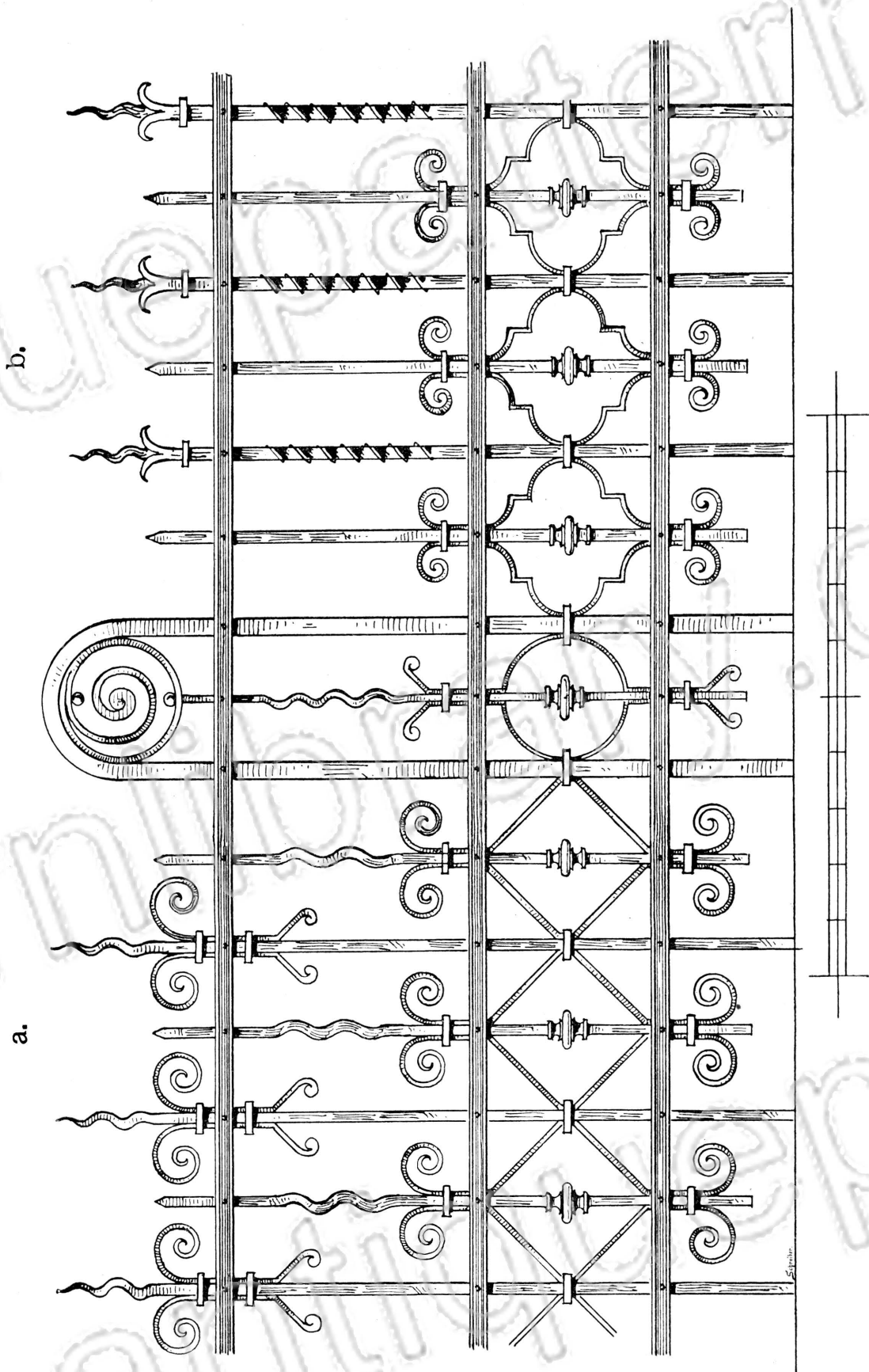

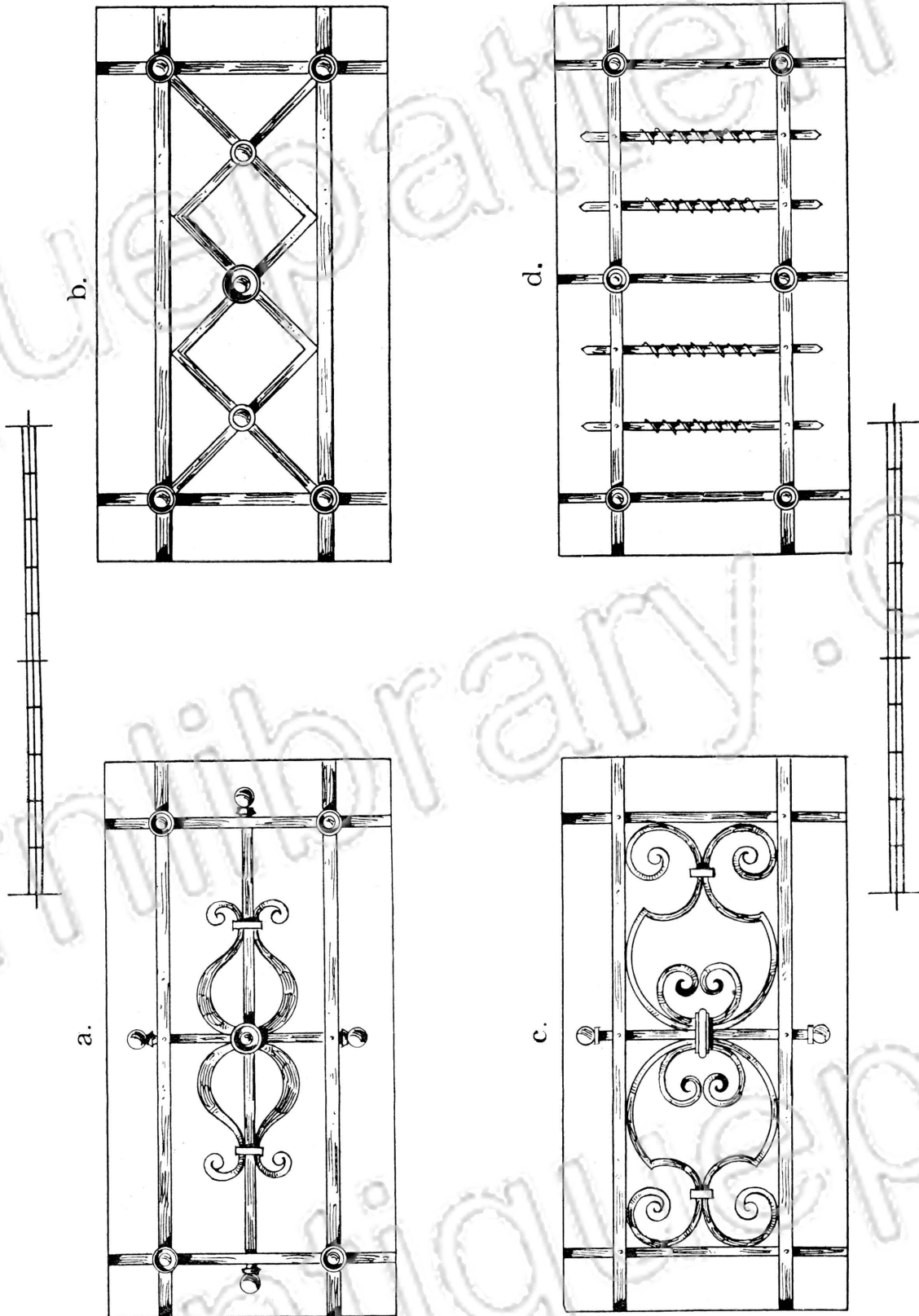

EINFACHE SCHMIEDE-ARBEITEN FÜR STADT UND LÄND.

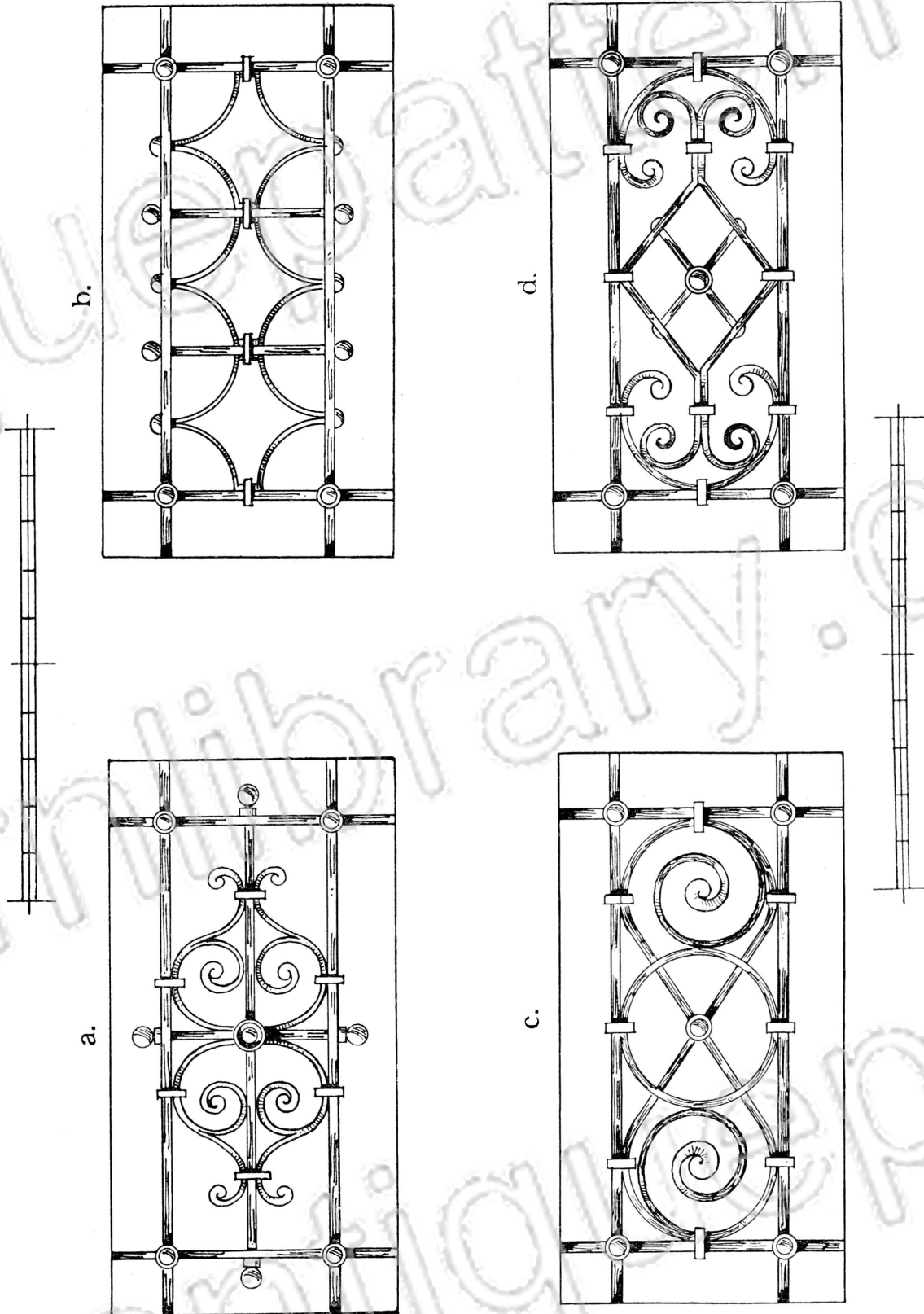

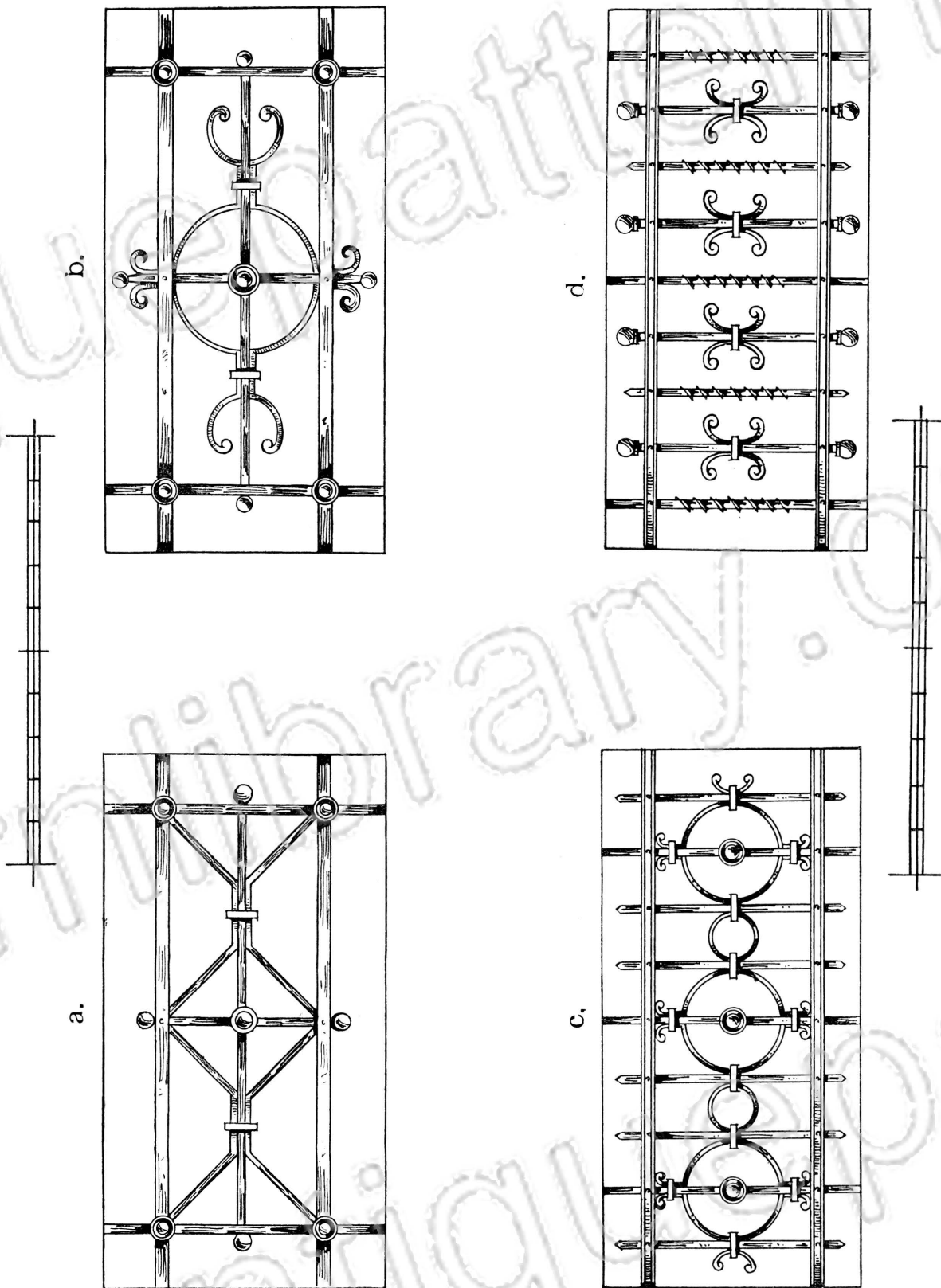

EINFACHE SCHMIEDE-ARBEITEN FÜR STADT UND LAND.

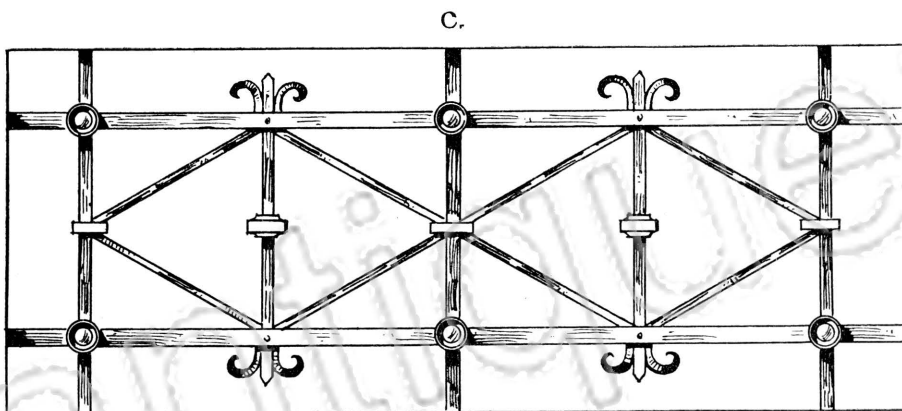
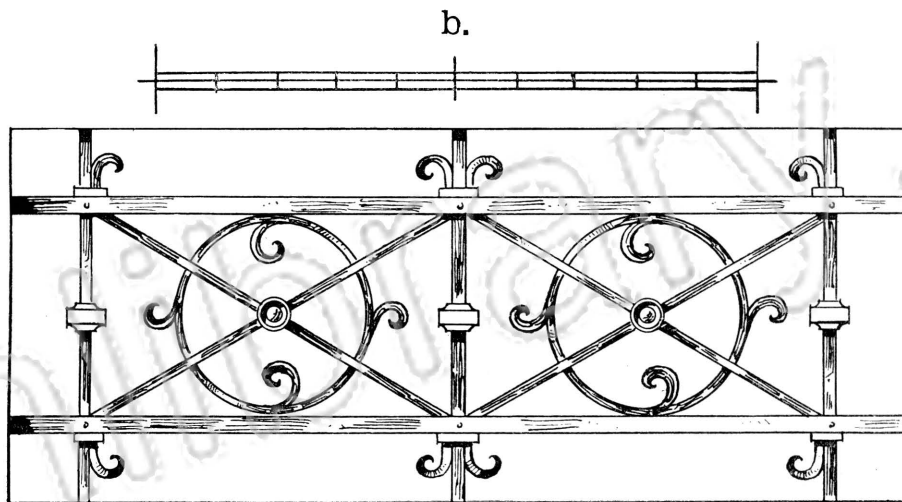
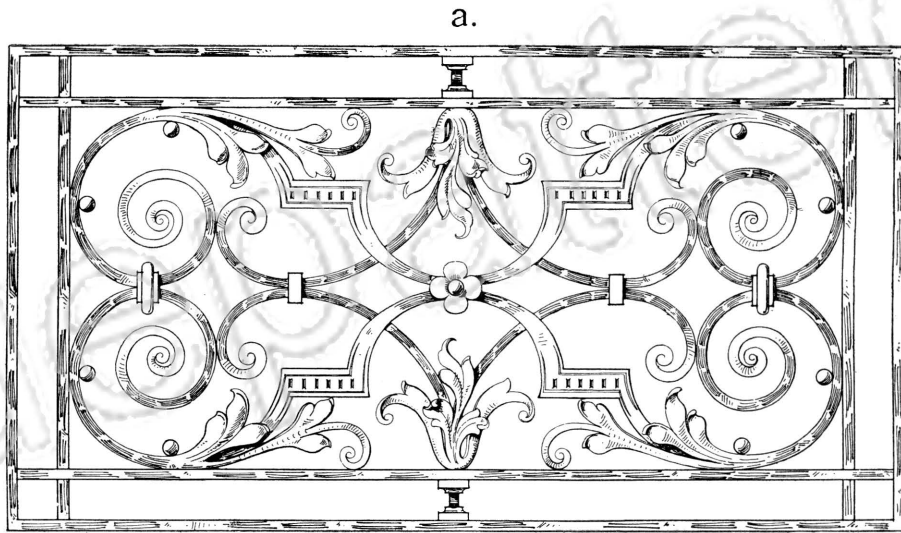

EINFACHE SCHMIEDE-ARBEITEN FÜR STADT UND LAND.

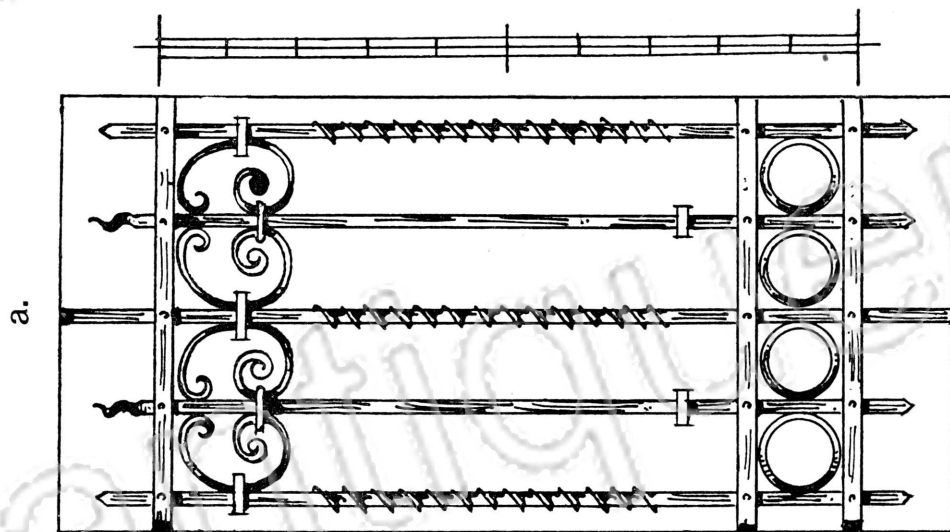
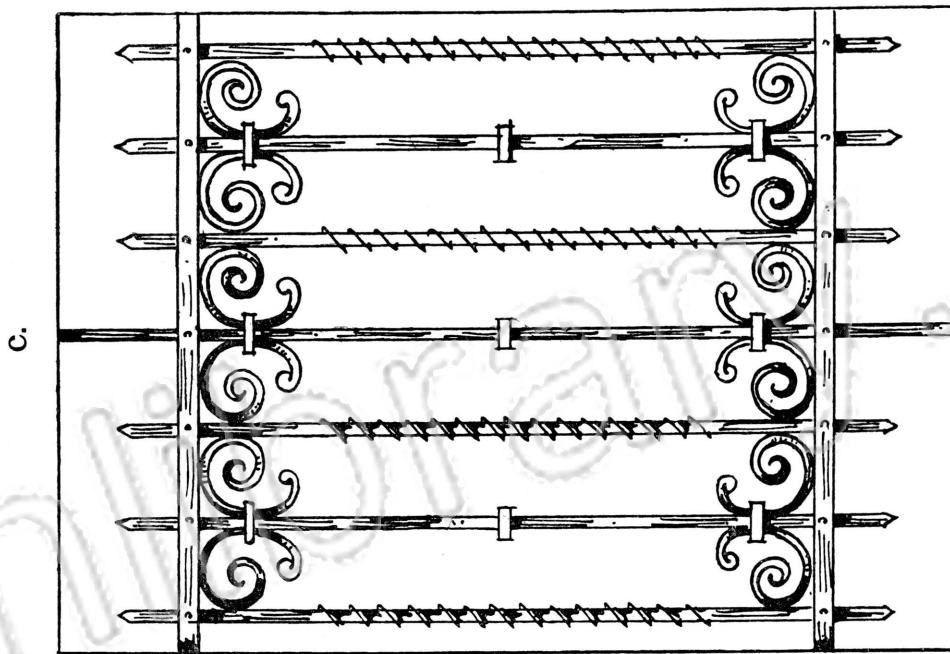
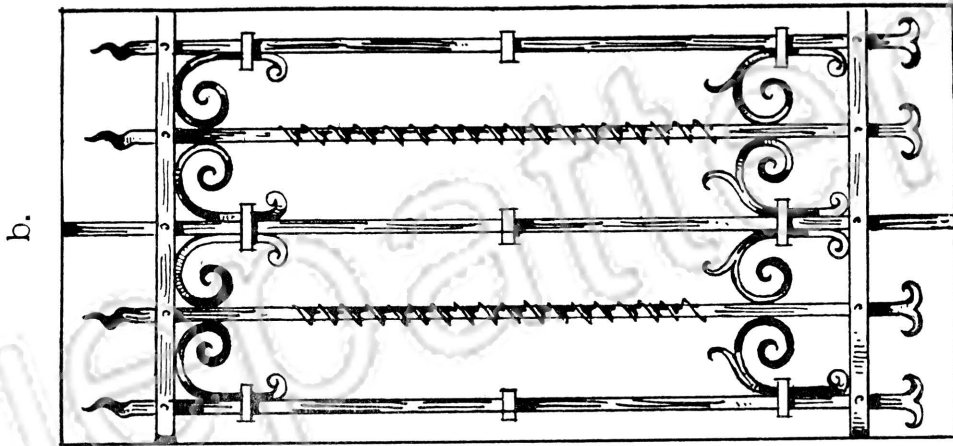

# EINFACHE SCHMIEDE-ARBEITEN FÜR STADT UND LÄND.

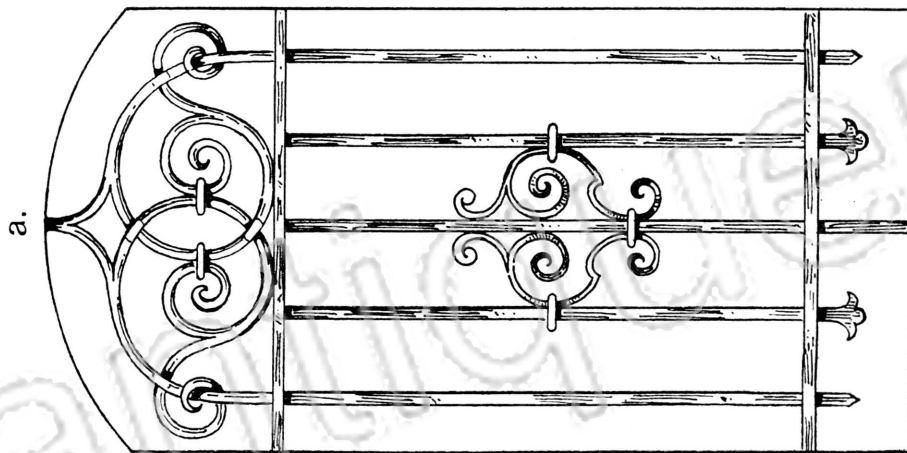
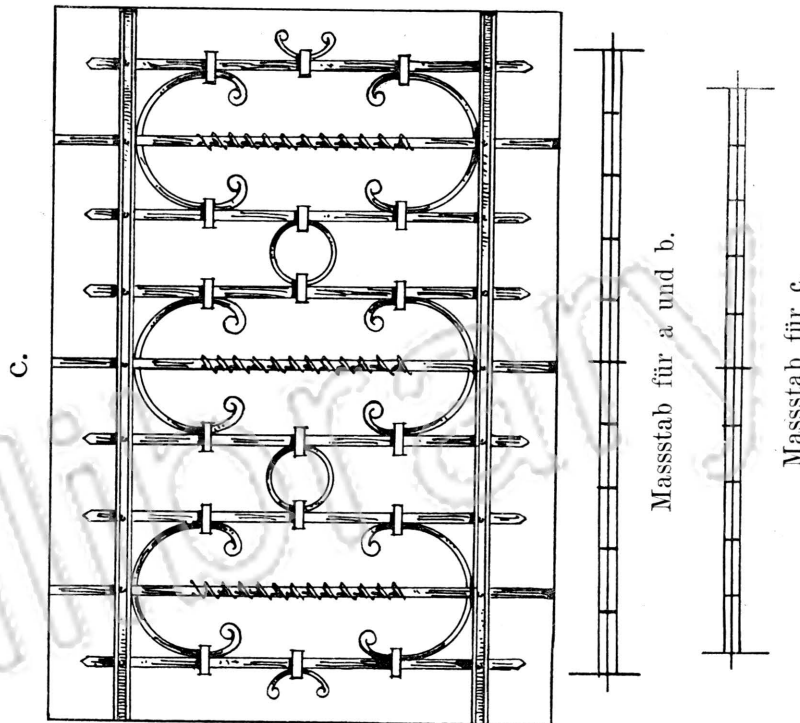
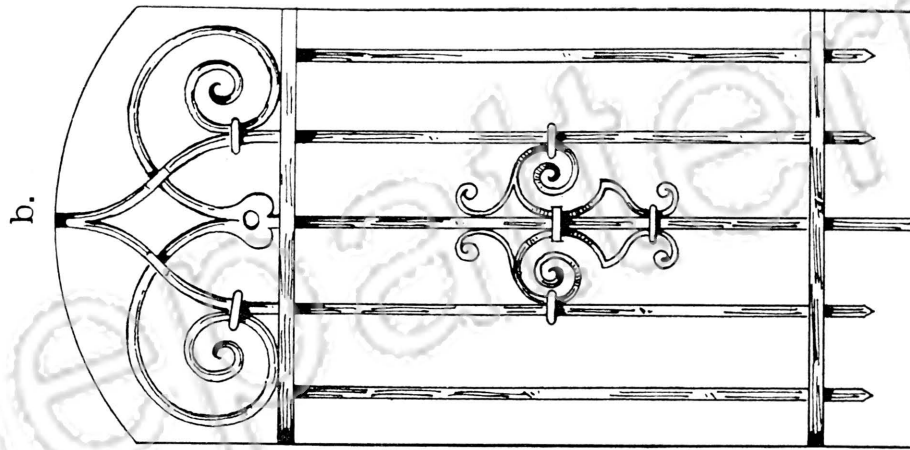



# EINFACHE SCHMIEDE-ARBEITEN FÜR STADT UND LAND.

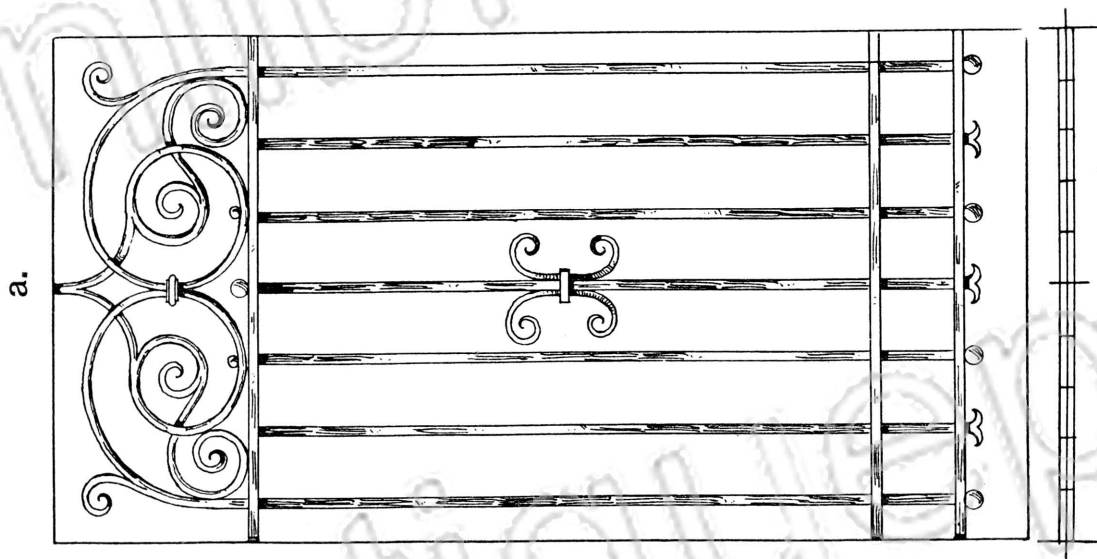
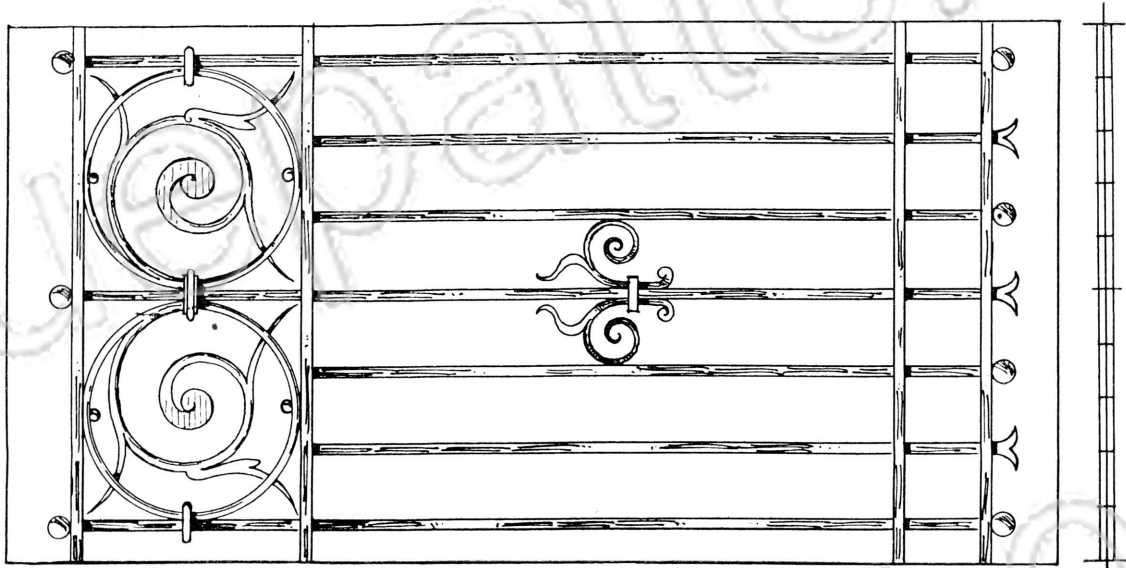

EINFACHE SCHMIEDE-ARBEITEN FÜR STADT UND LAND.

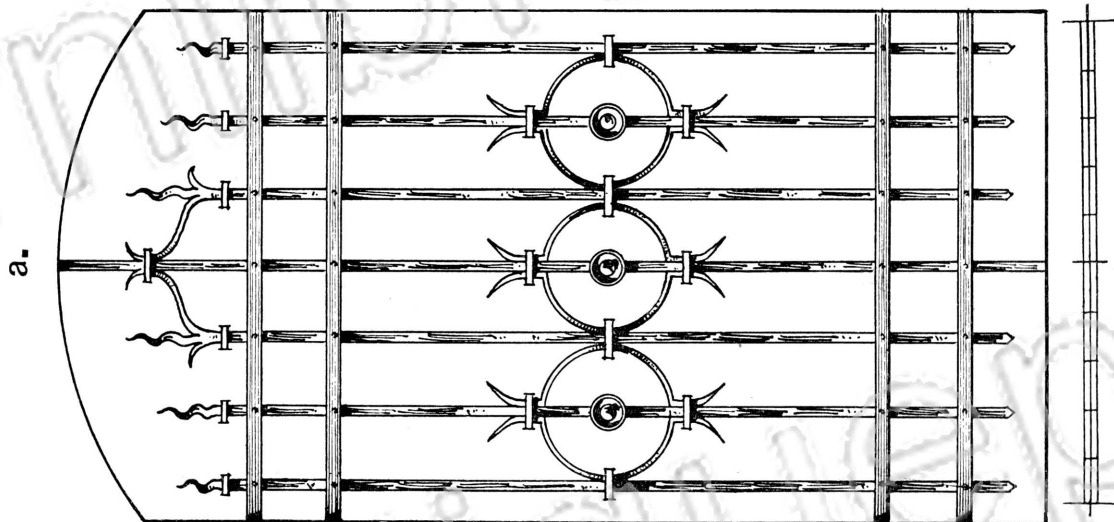
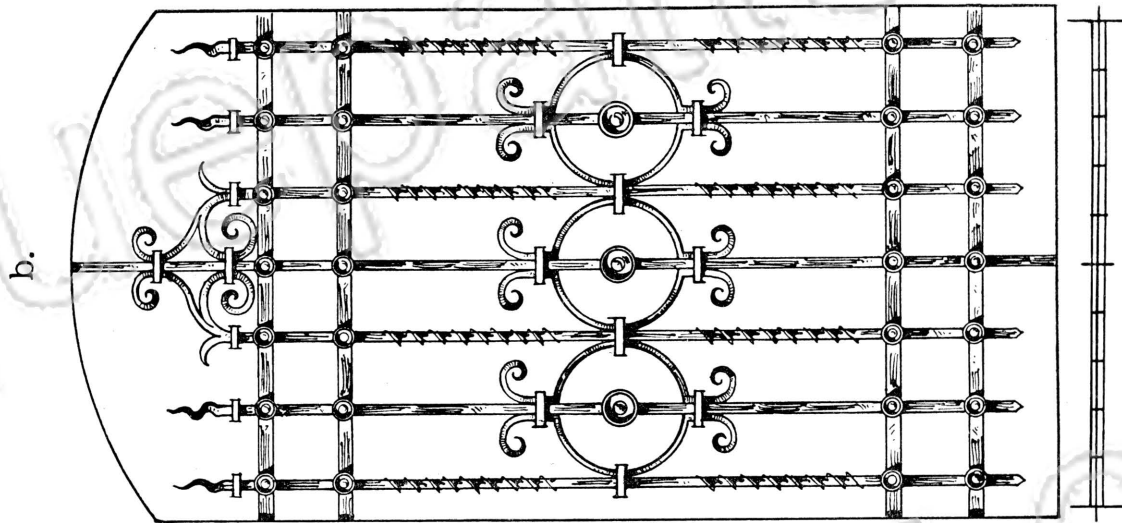

# EINFACHE SCHMIEDE-ARBEITEN FÜR STADT UND LÄND.

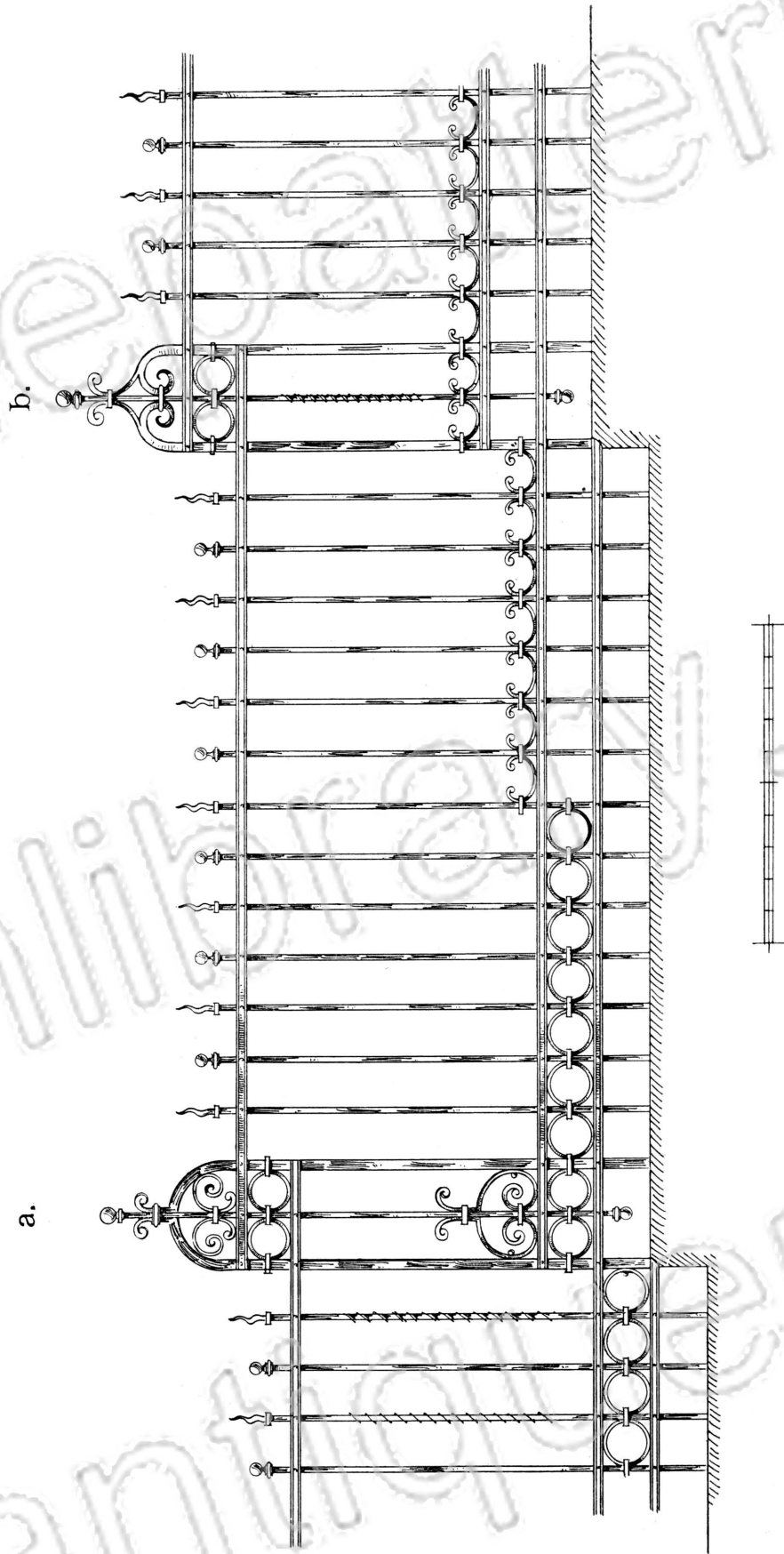

EINFACHE SCHMIEDE-ARBEITEN FÜR STADT UND LAND.

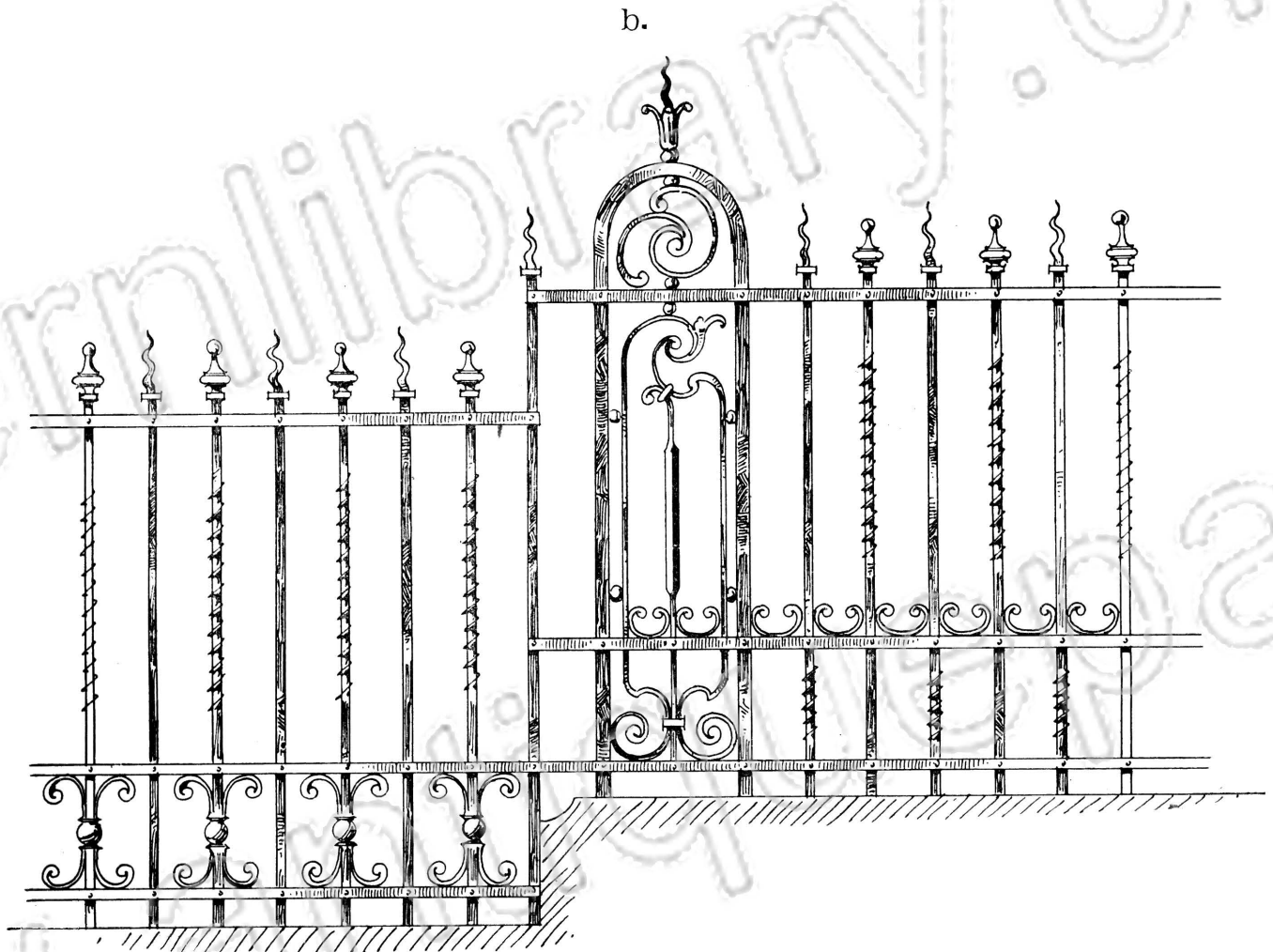
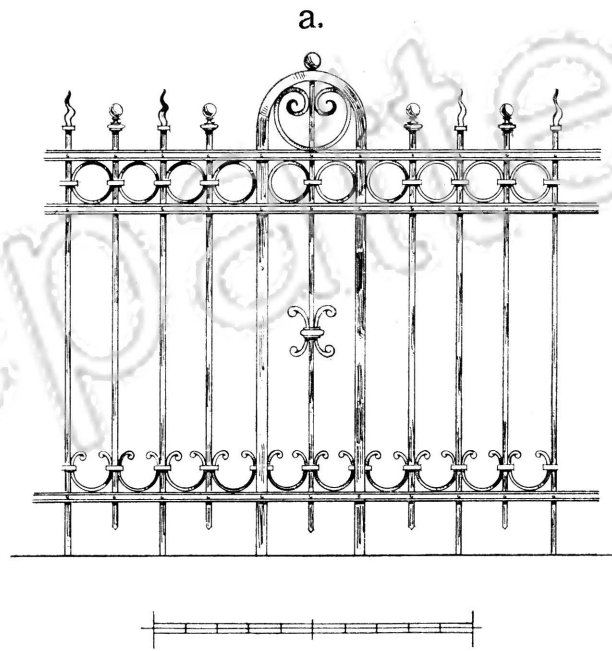

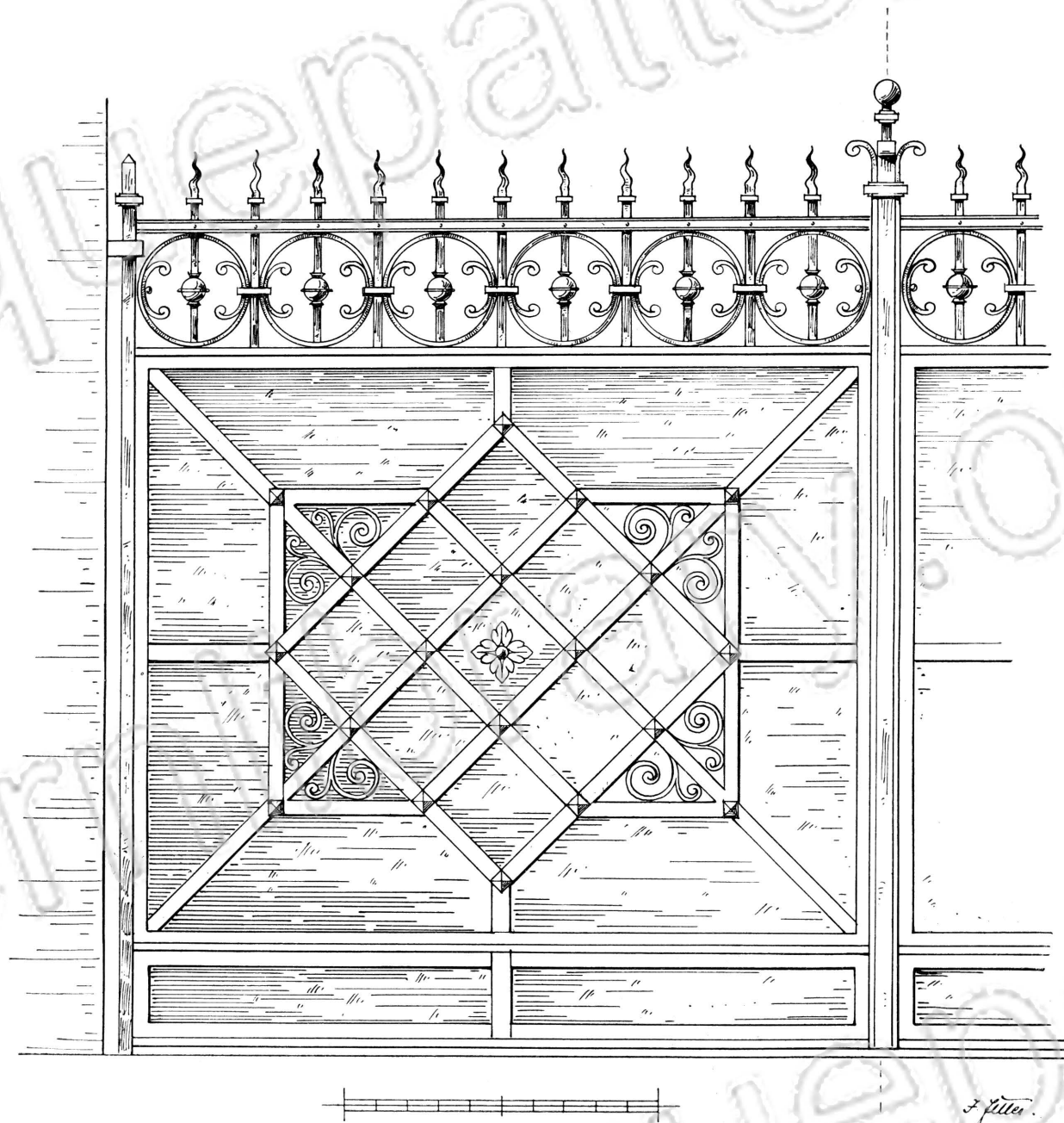

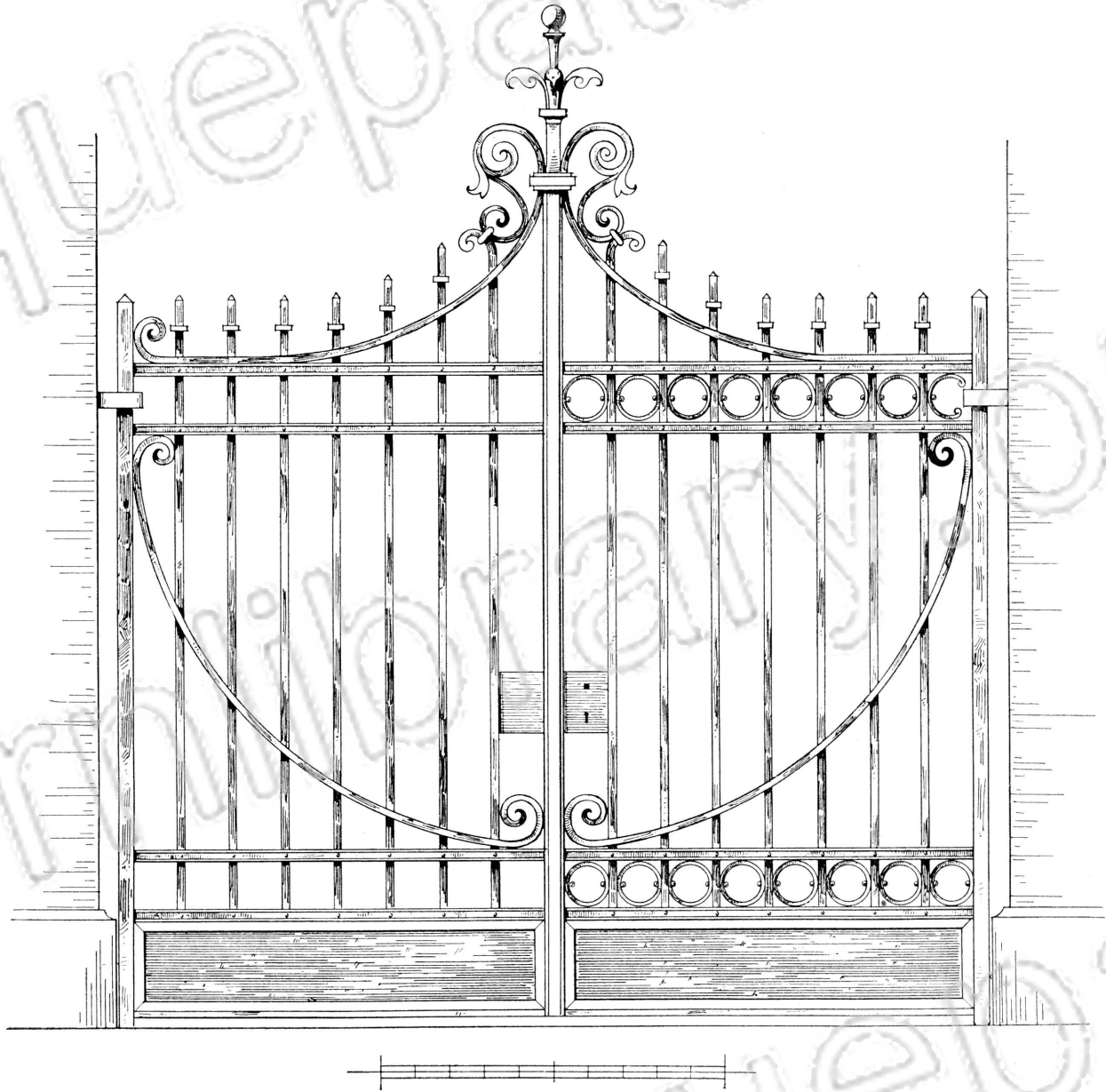

EINFACHE SCHMIEDE-ARBEITEN FÜR STADT UND LAND.

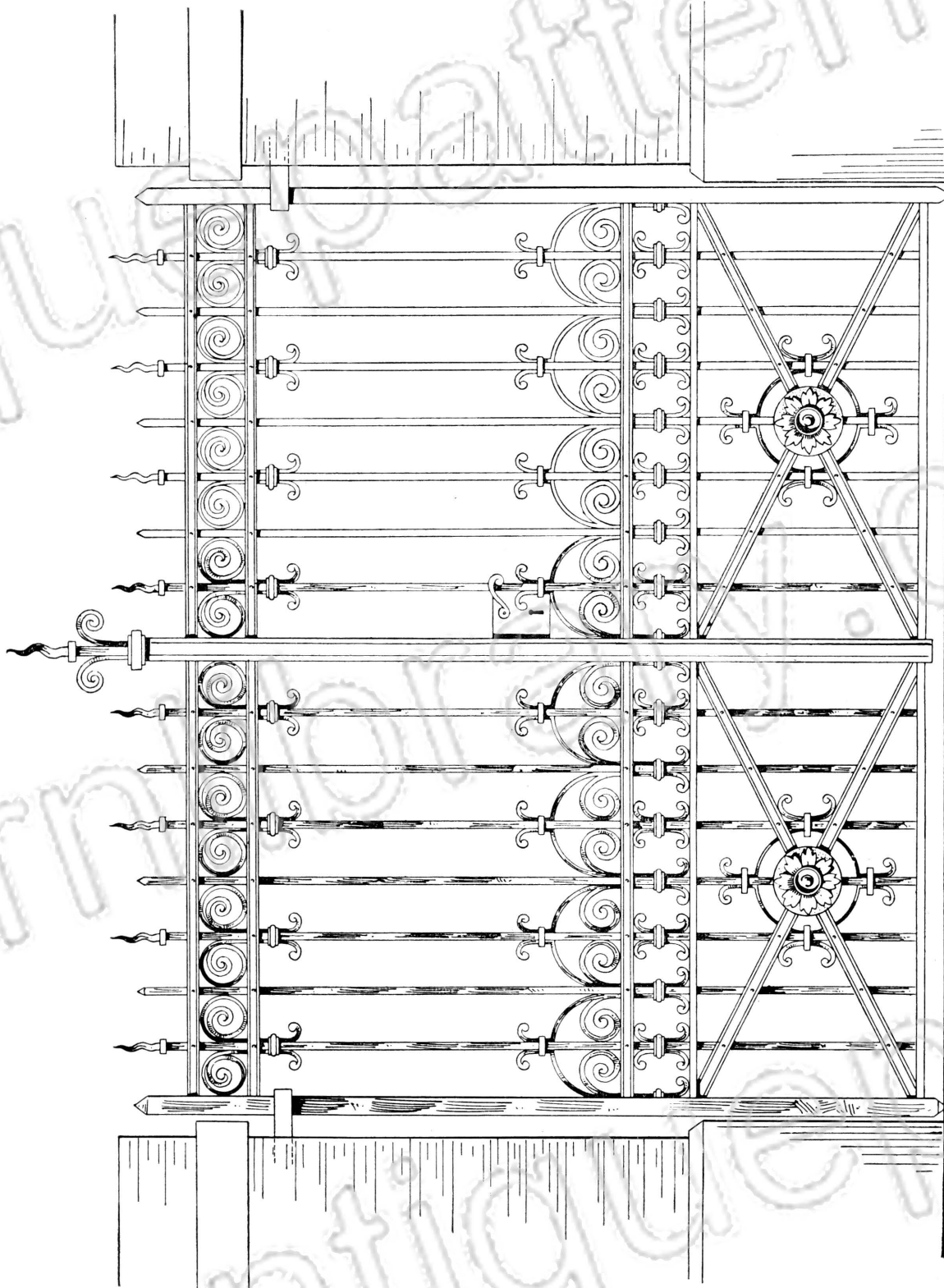

EINFACHE SCHMIEDE-ARBEITEN FÜR STADT UND LÄND.

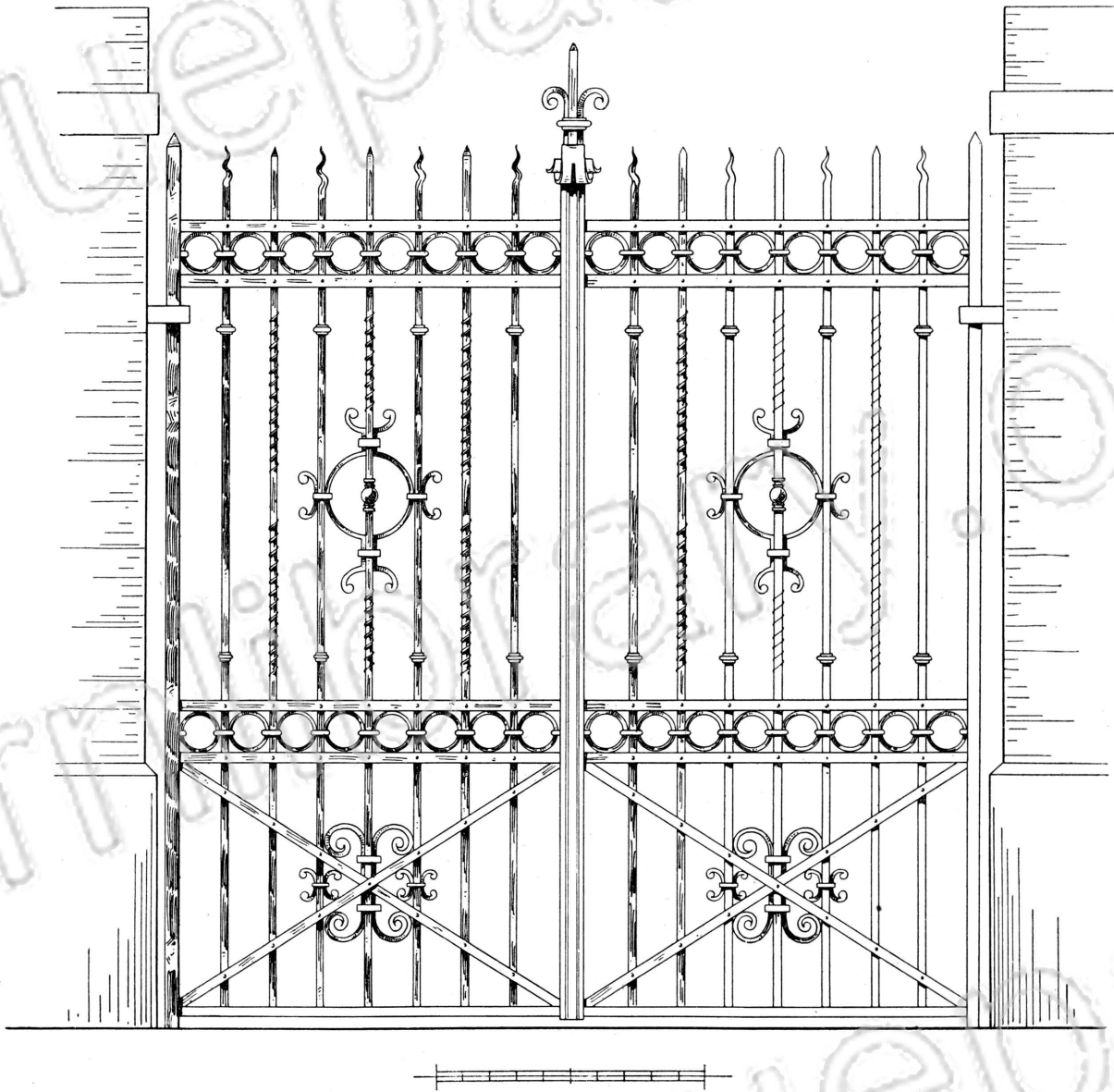



EINFACHE SCHMIEDE-ARBEITEN FÜR STADT UND LÄND.



EINFACHE SCHMIEDE-ARBEITEN FÜR STADT UND LAND.

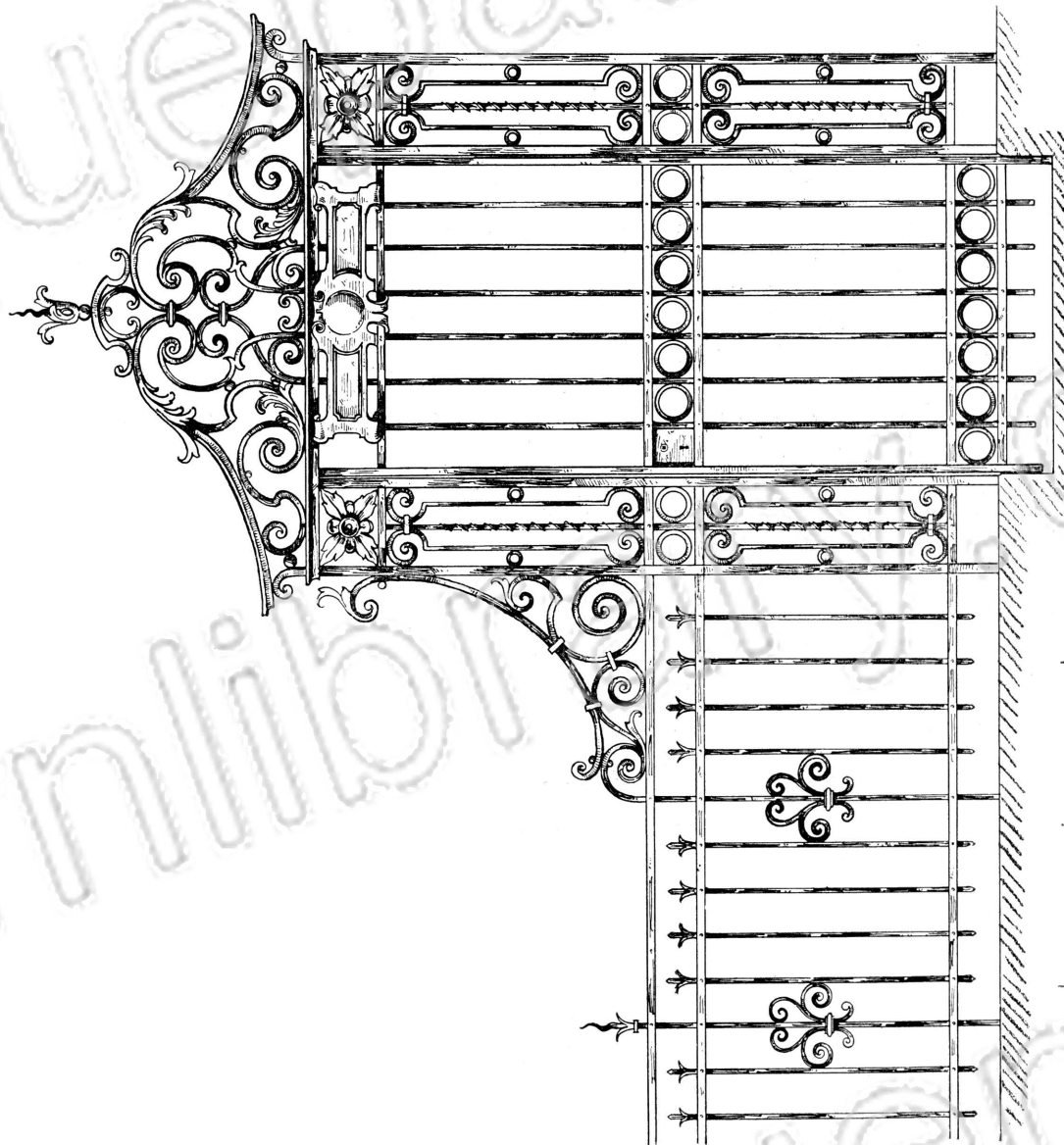

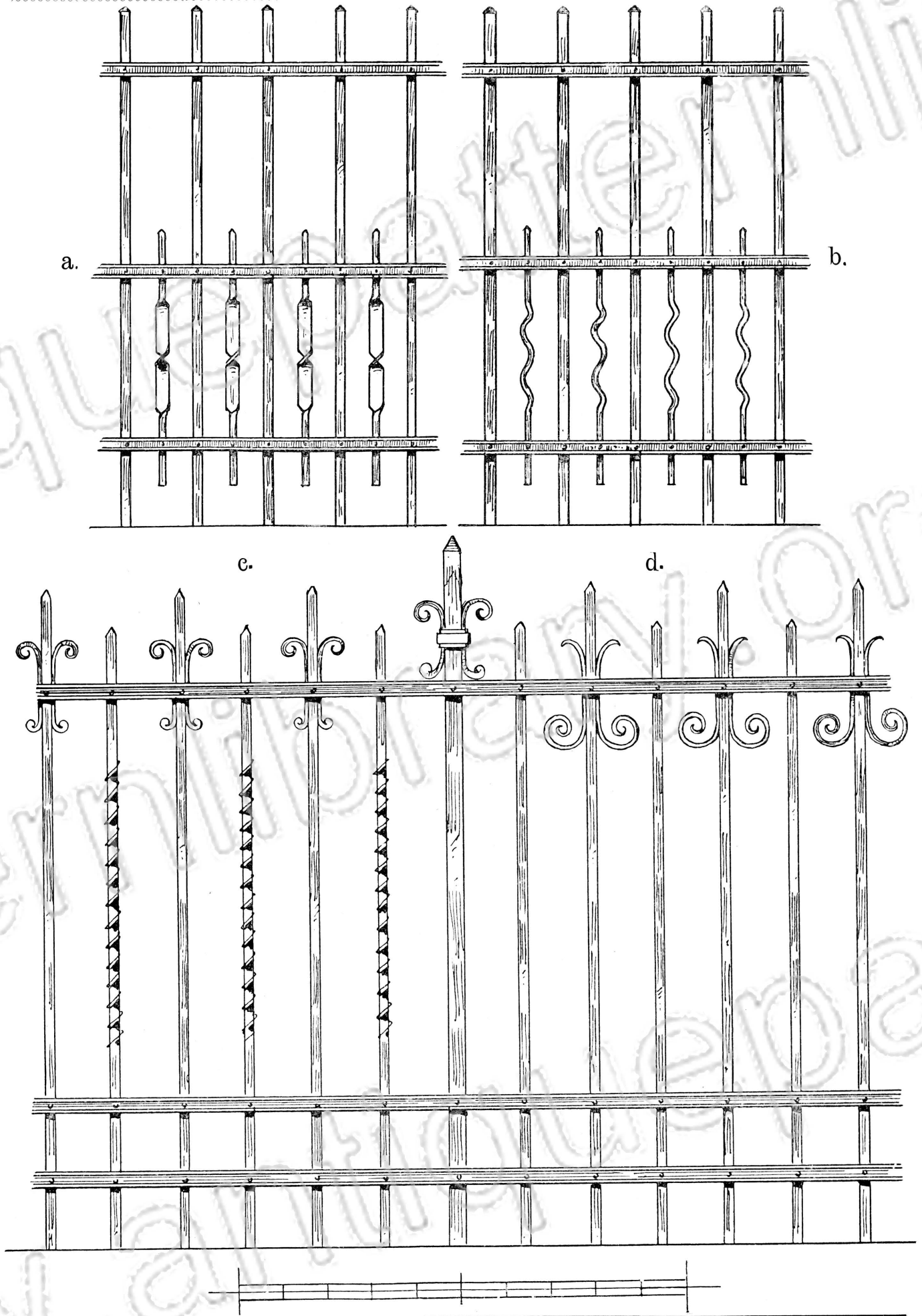

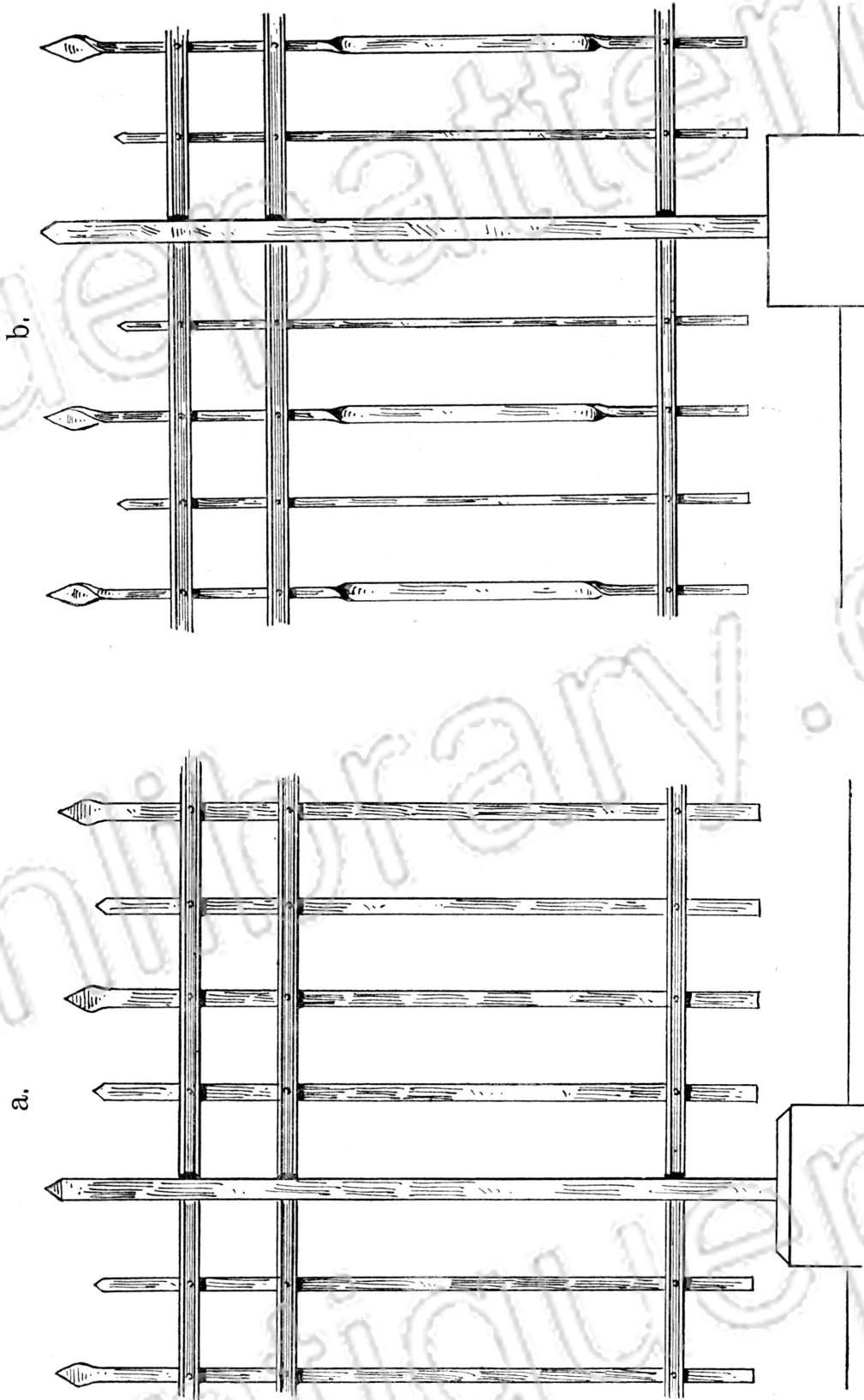

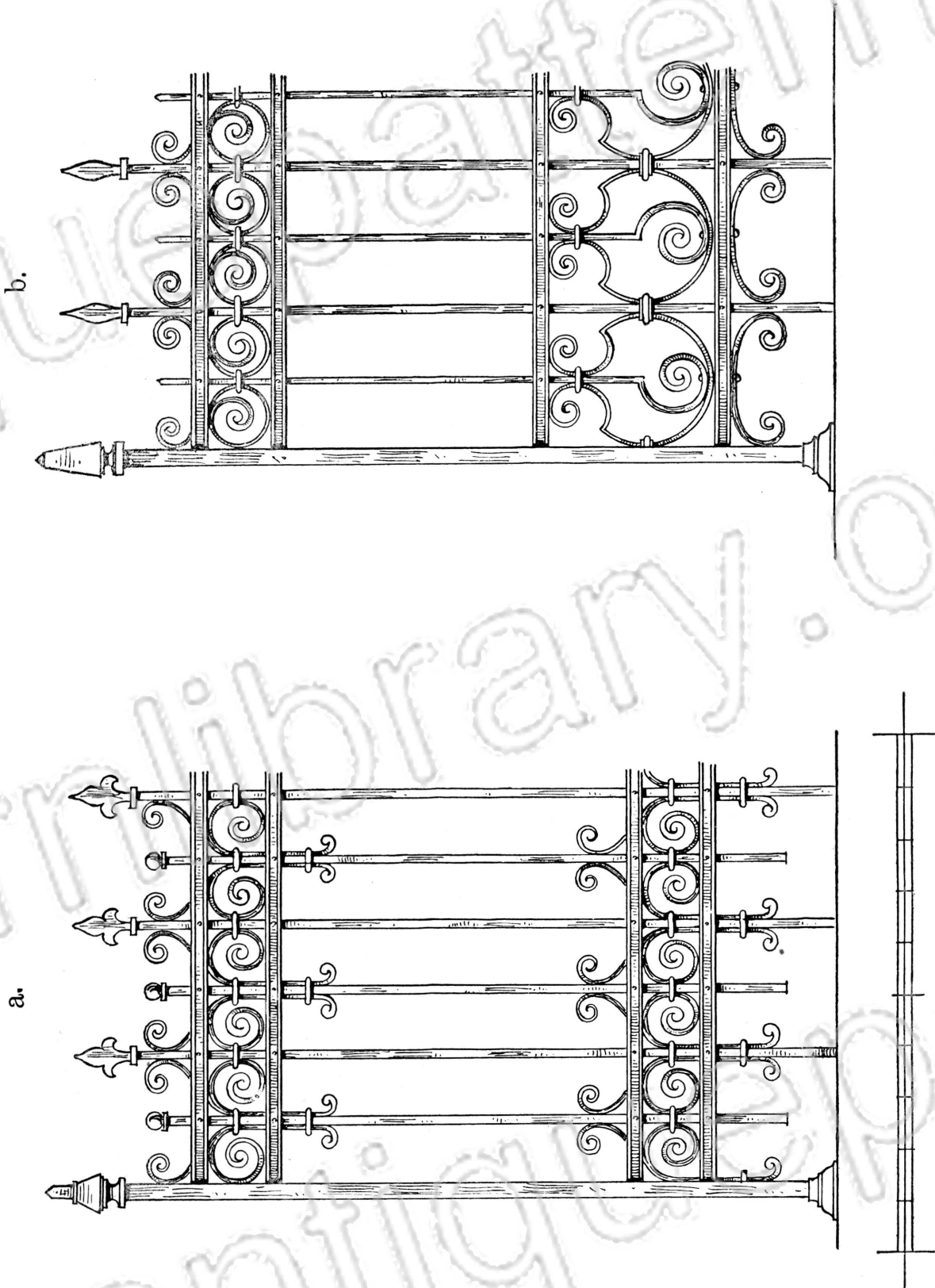

# EINFACHE SCHMIEDE-ARBEITEN FÜR STADT UND LAND.

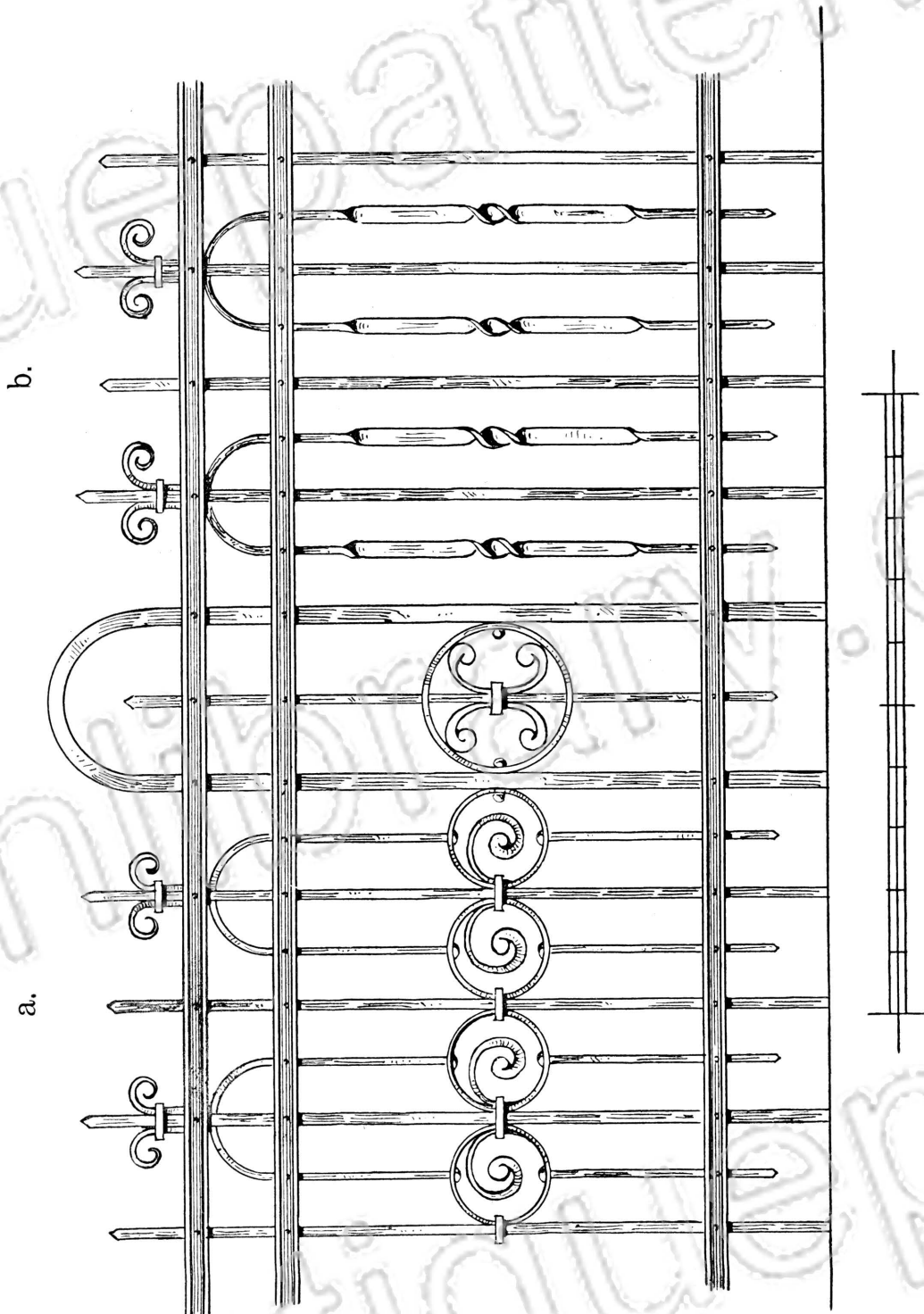

EINFACHE SCHMIEDE-ARBEITEN FÜR STADT UND LAND.

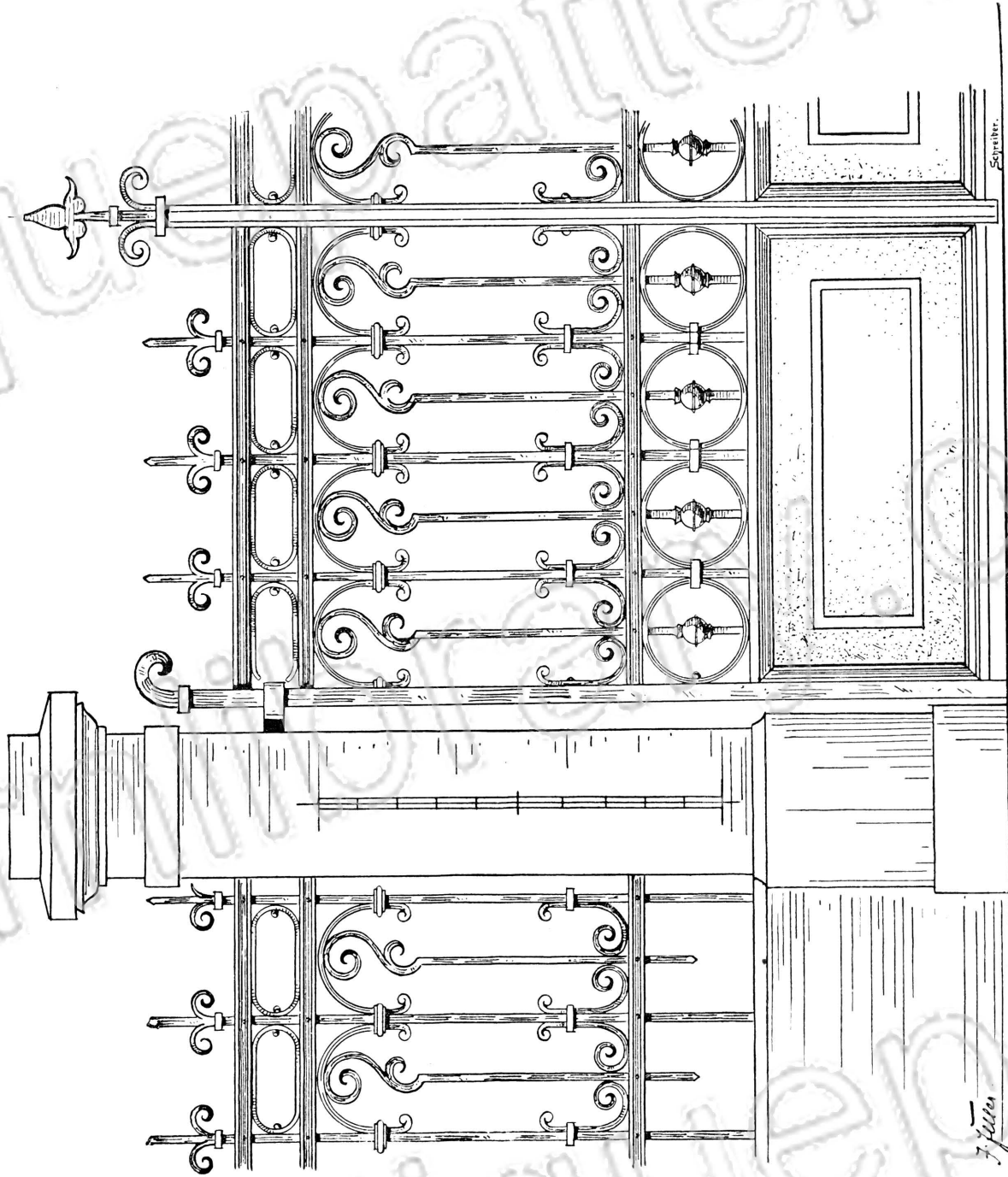

EINFACHE SCHMIEDE-ARBEITEN FÜR STADT UND LÄND.

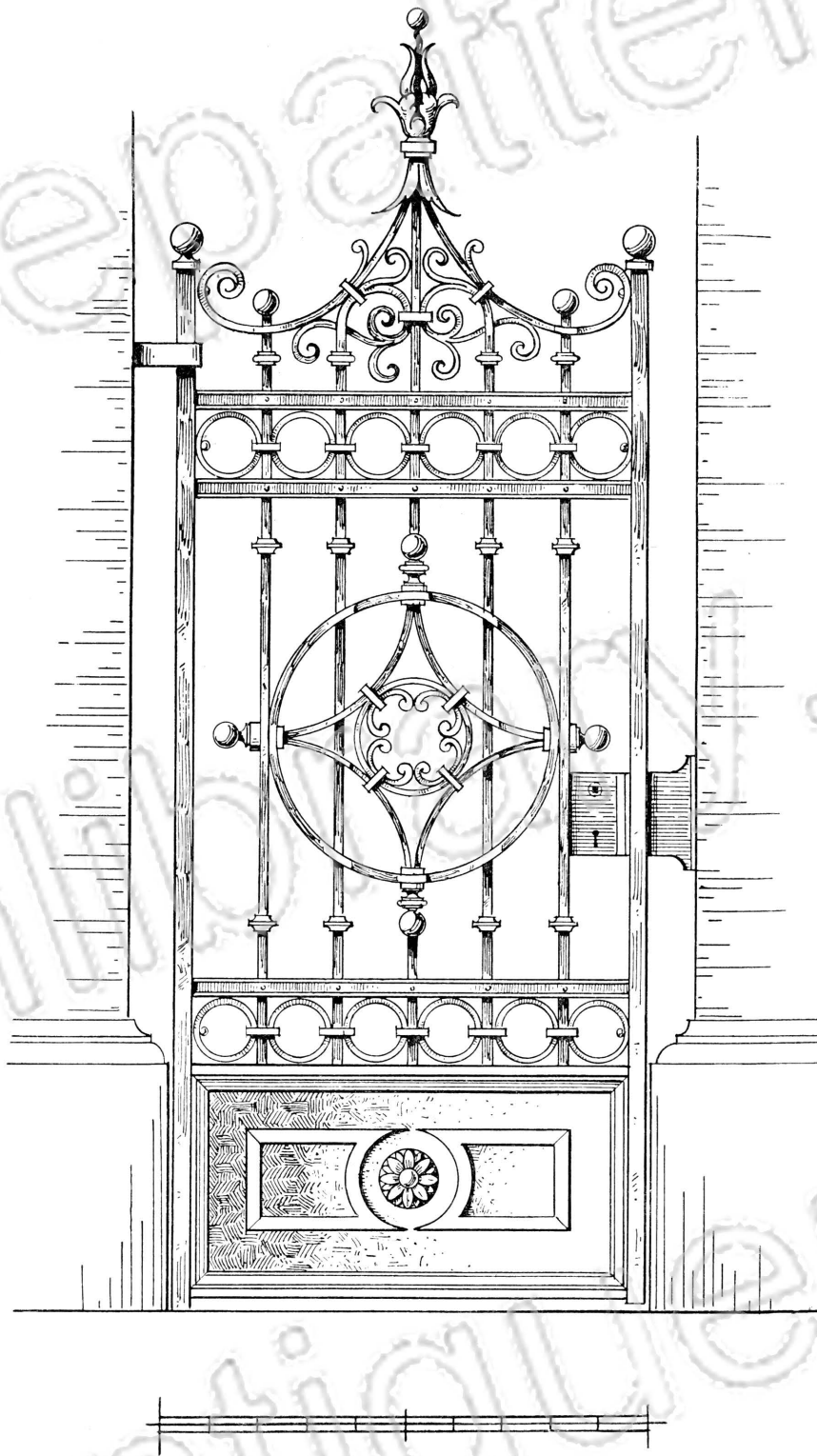



EINFACHE SCHMIEDE-ARBEITEN FÜR STADT UND LAND.

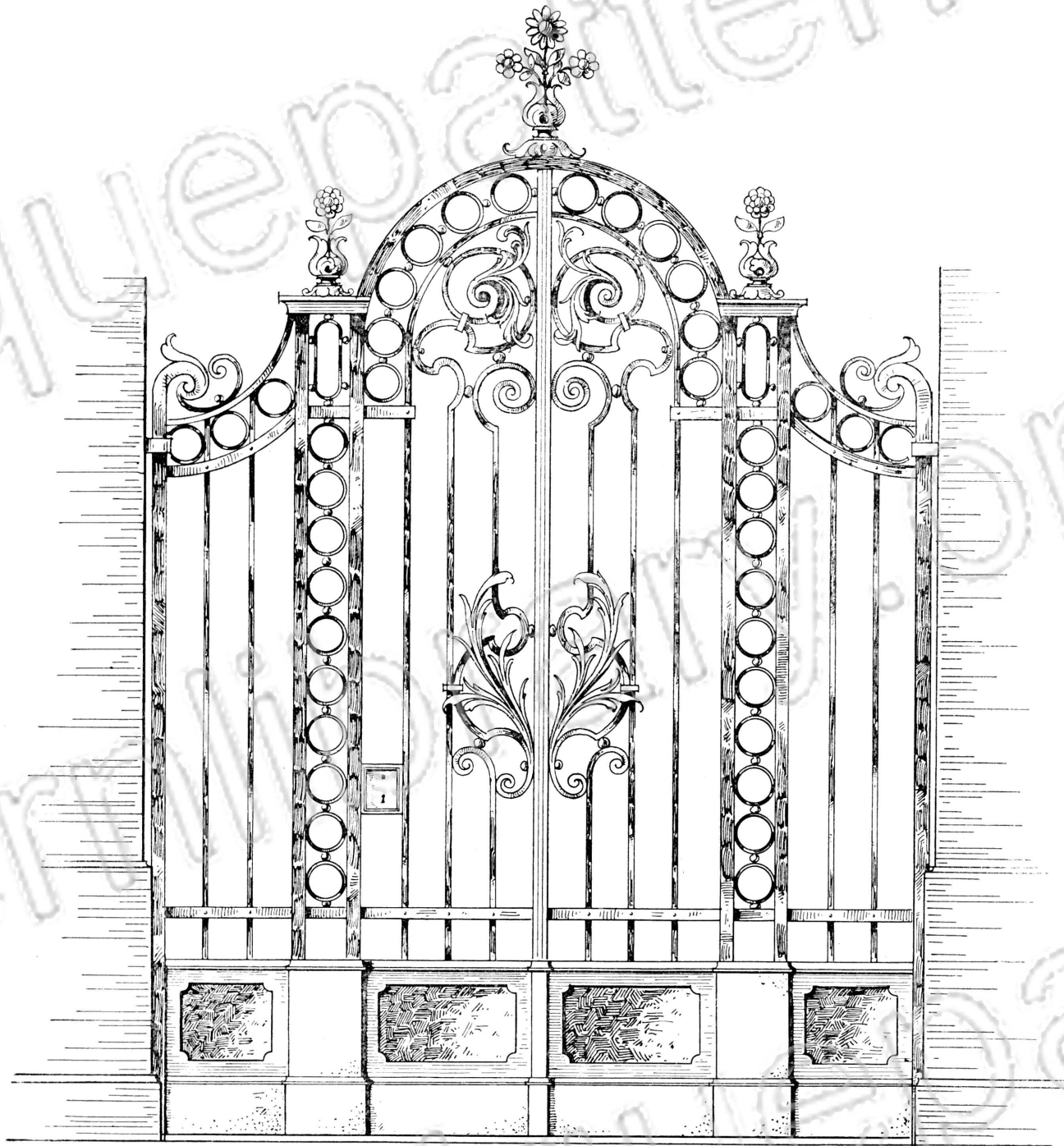

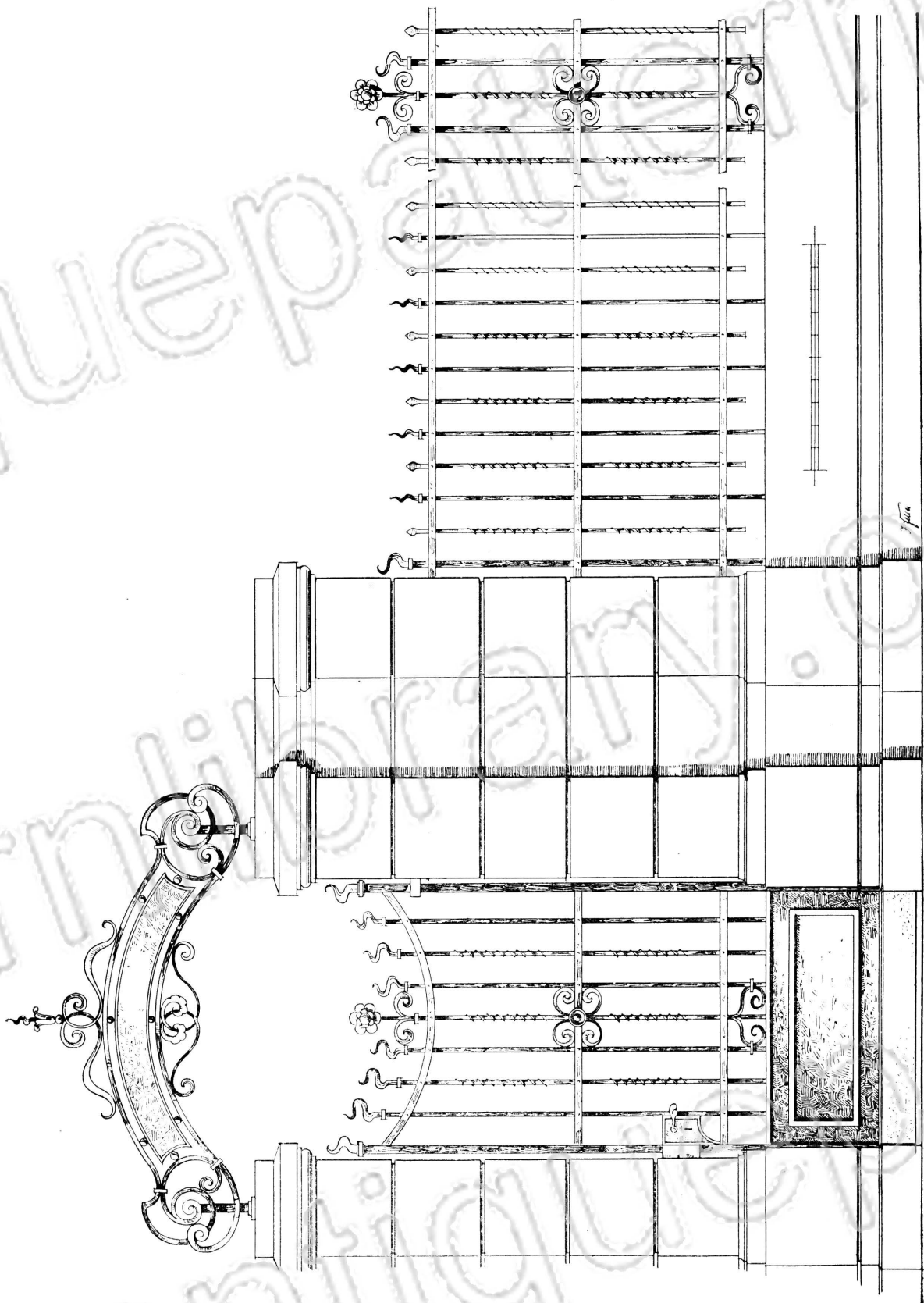

# EINFACHE SCHMIEDE-ARBEITEN FÜR STADT UND LÄND.

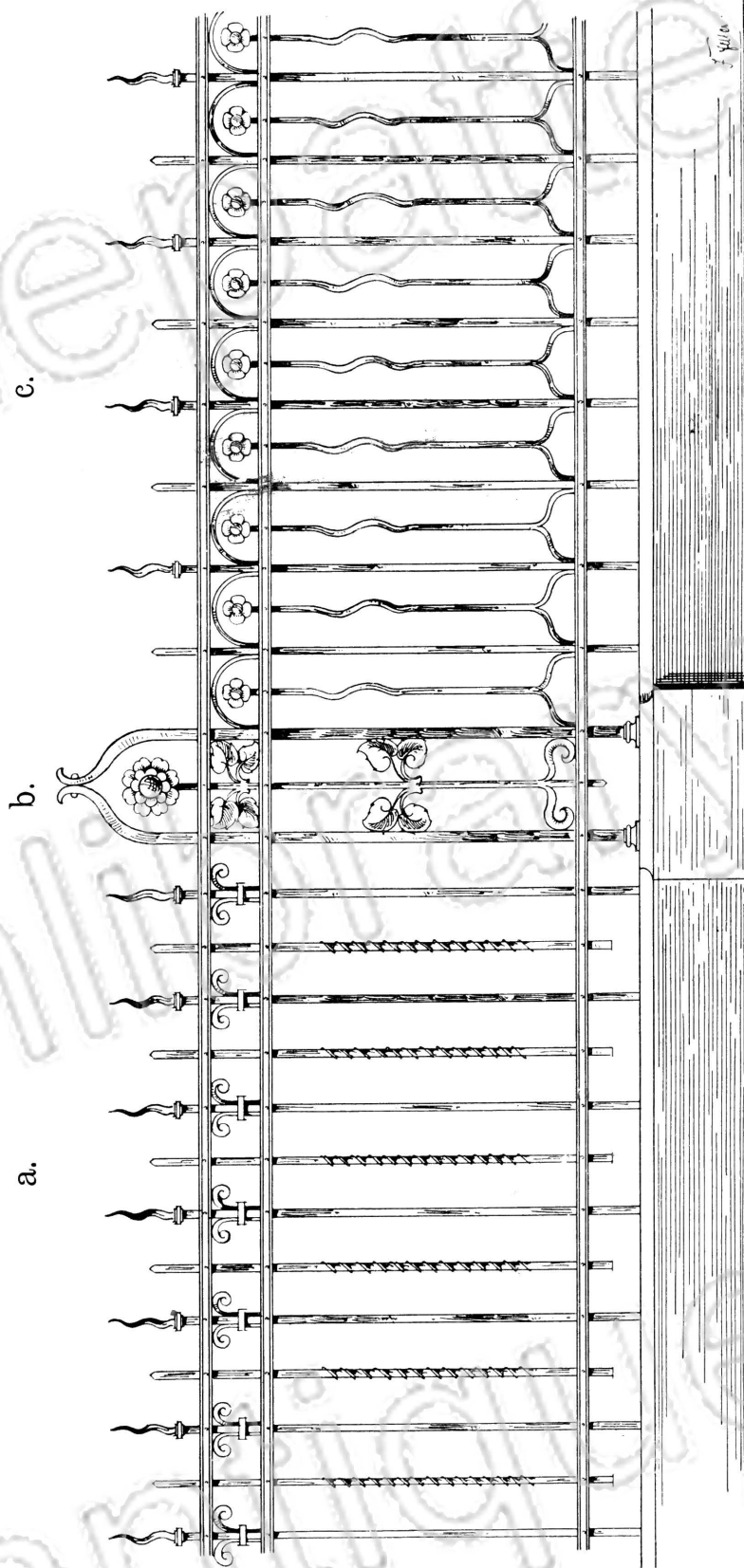

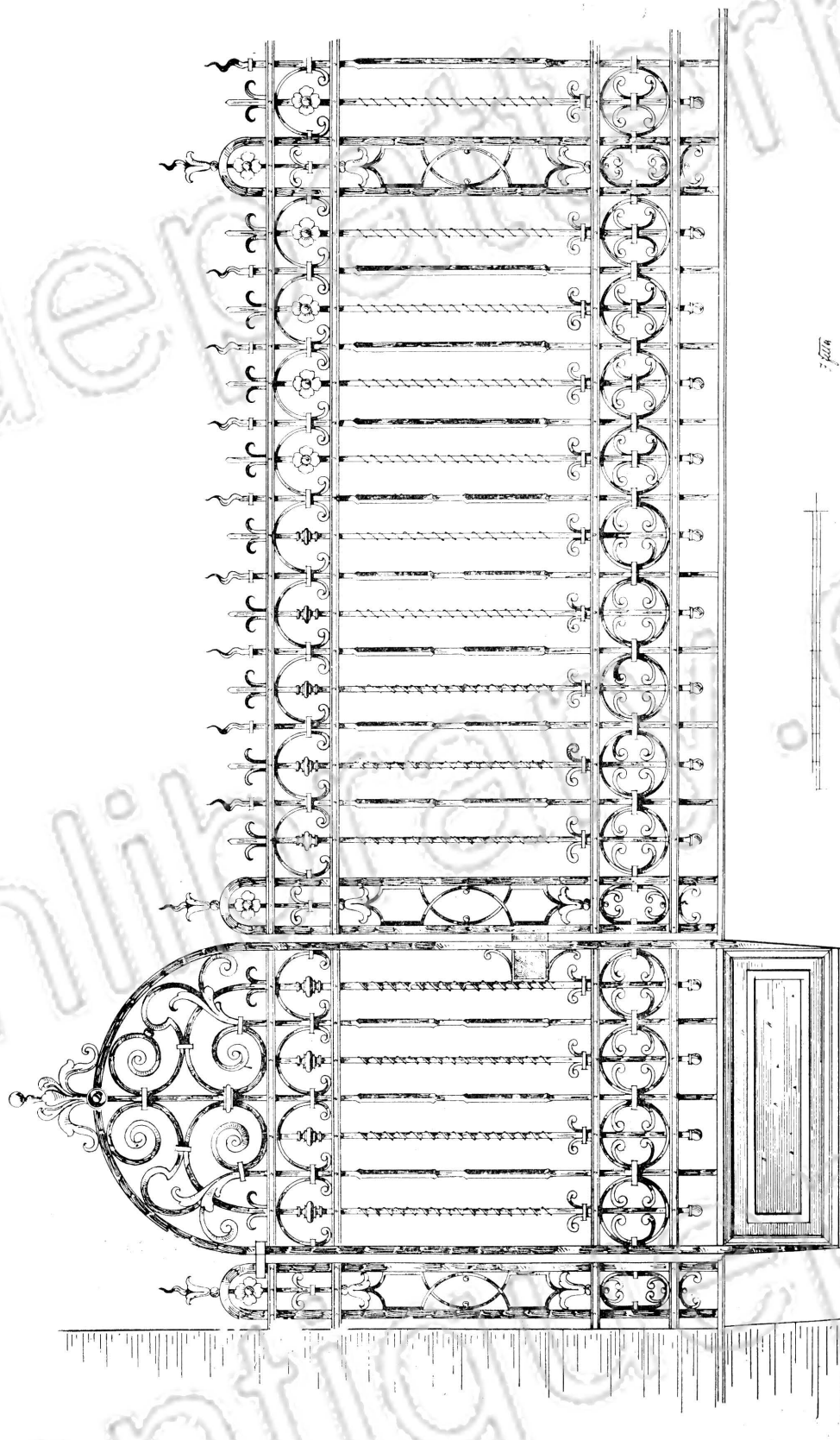

Feller, Einfache Schmiedearbeiten.

Verlag von Otto Maier in Ravensburg.

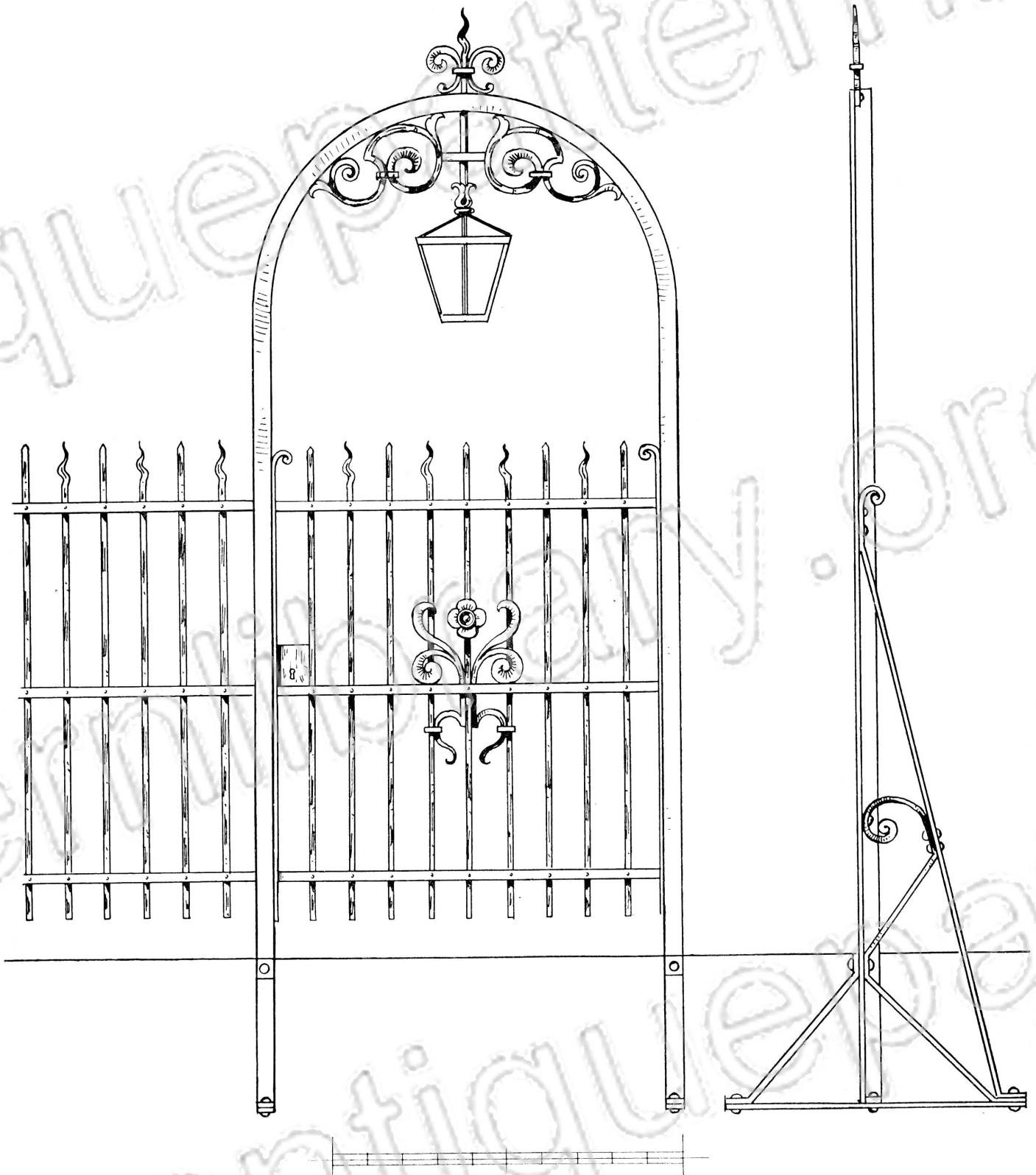

Feller, Einfache Schmiedearbeiten.

Verlag von Otto Maier in Ravensburg.

EINFACHE SCHMIEDE-ÄRBEITEN FÜR STÄDT UND LÄND.

a.

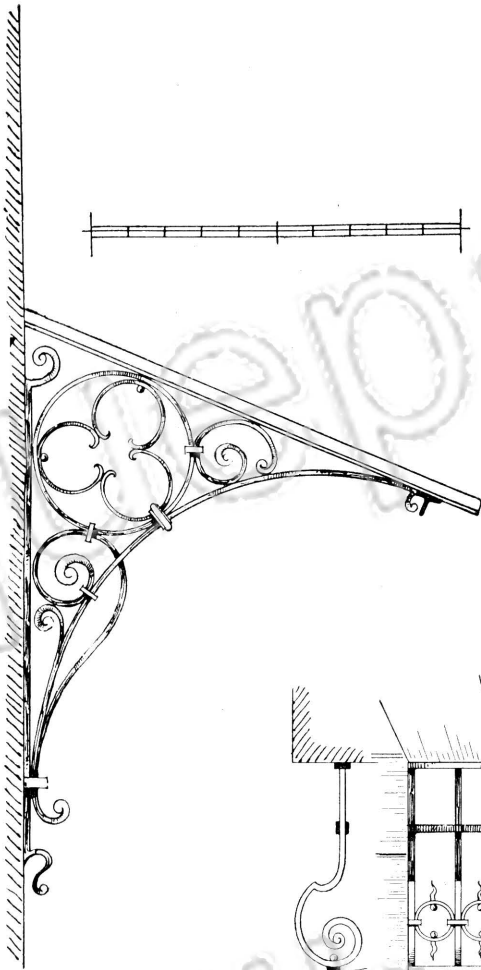

b.

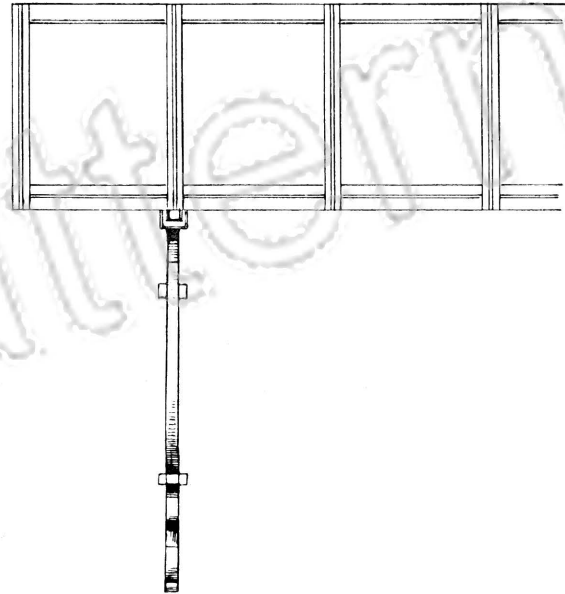

c.

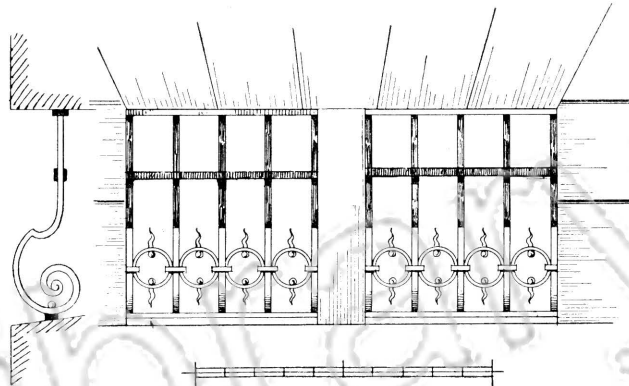

d.

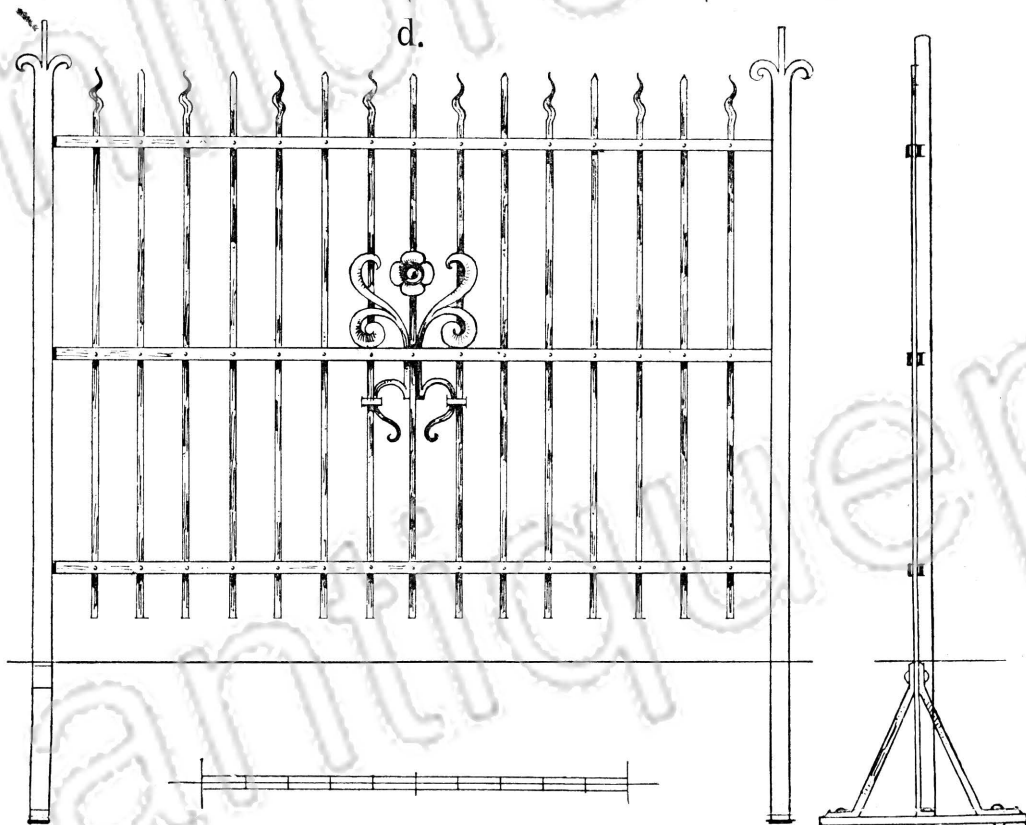



Feller, Eisenbeschneidarbeiten.

Verlag von Otto Maier in Ravensburg.





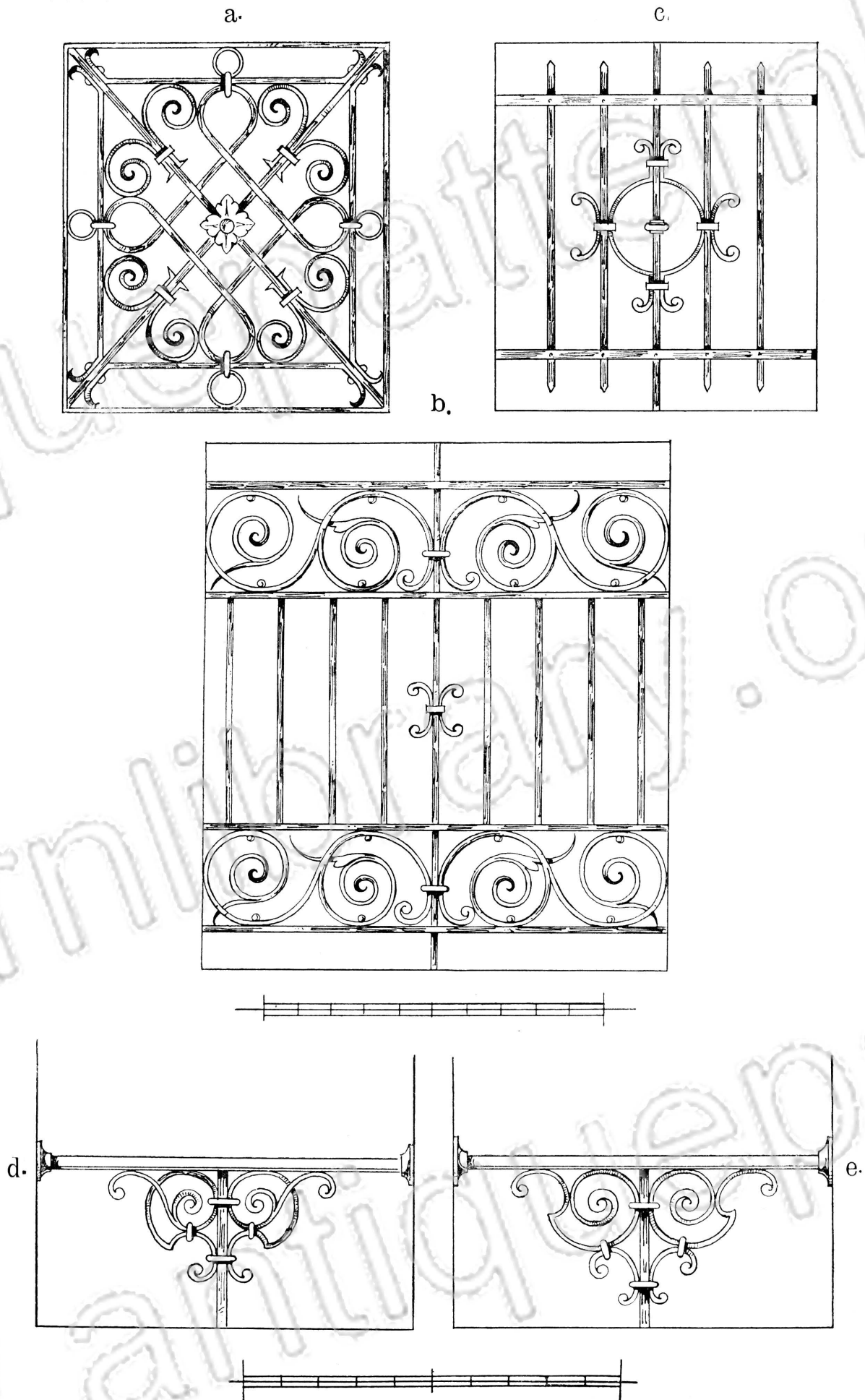

EINFACHE SCHMIEDE-ARBEITEN FÜR STADT UND LAND.

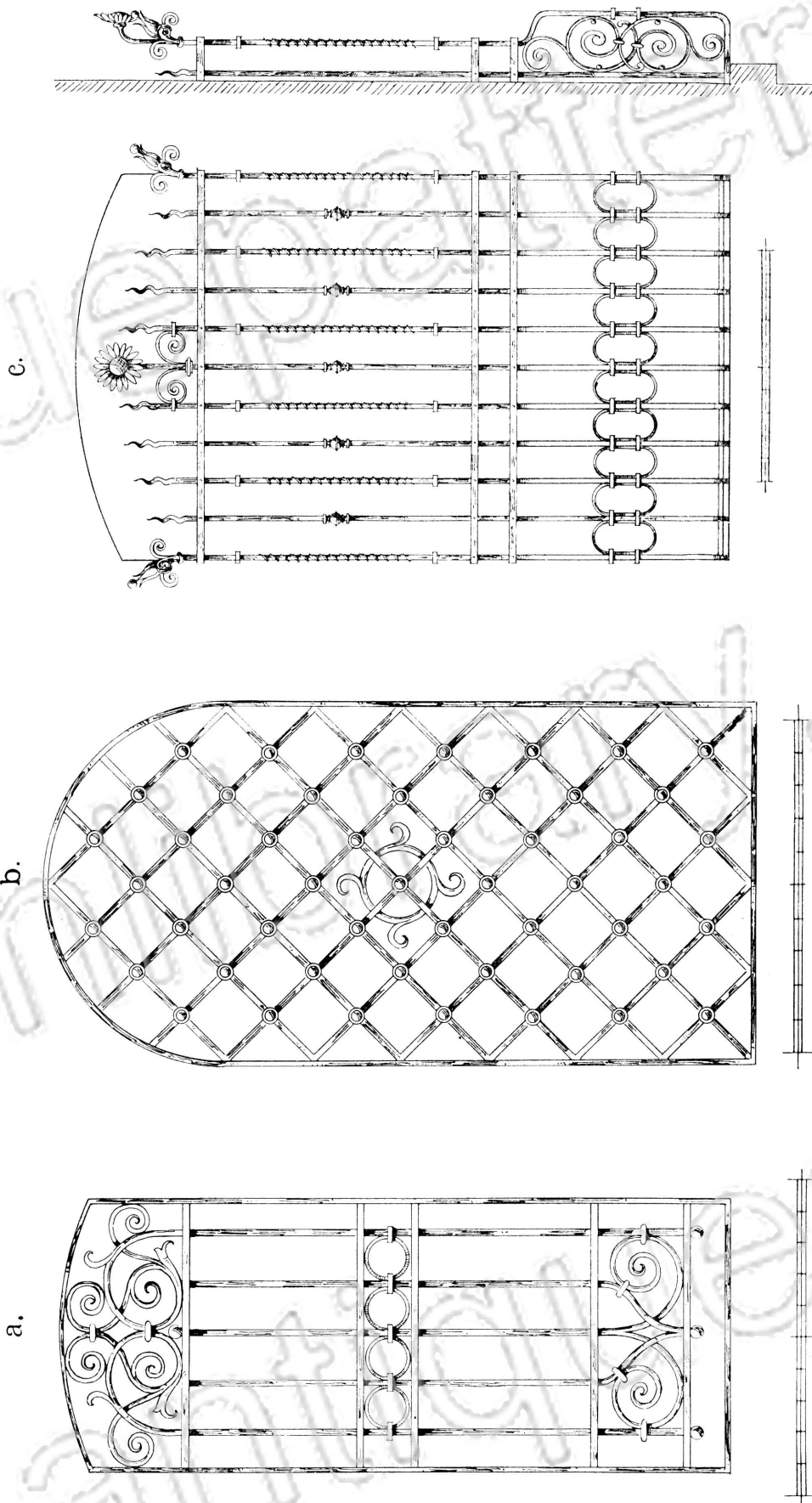

EINFACHE SCHMIEDE-ARBEITEN FÜR STADT UND LAND.

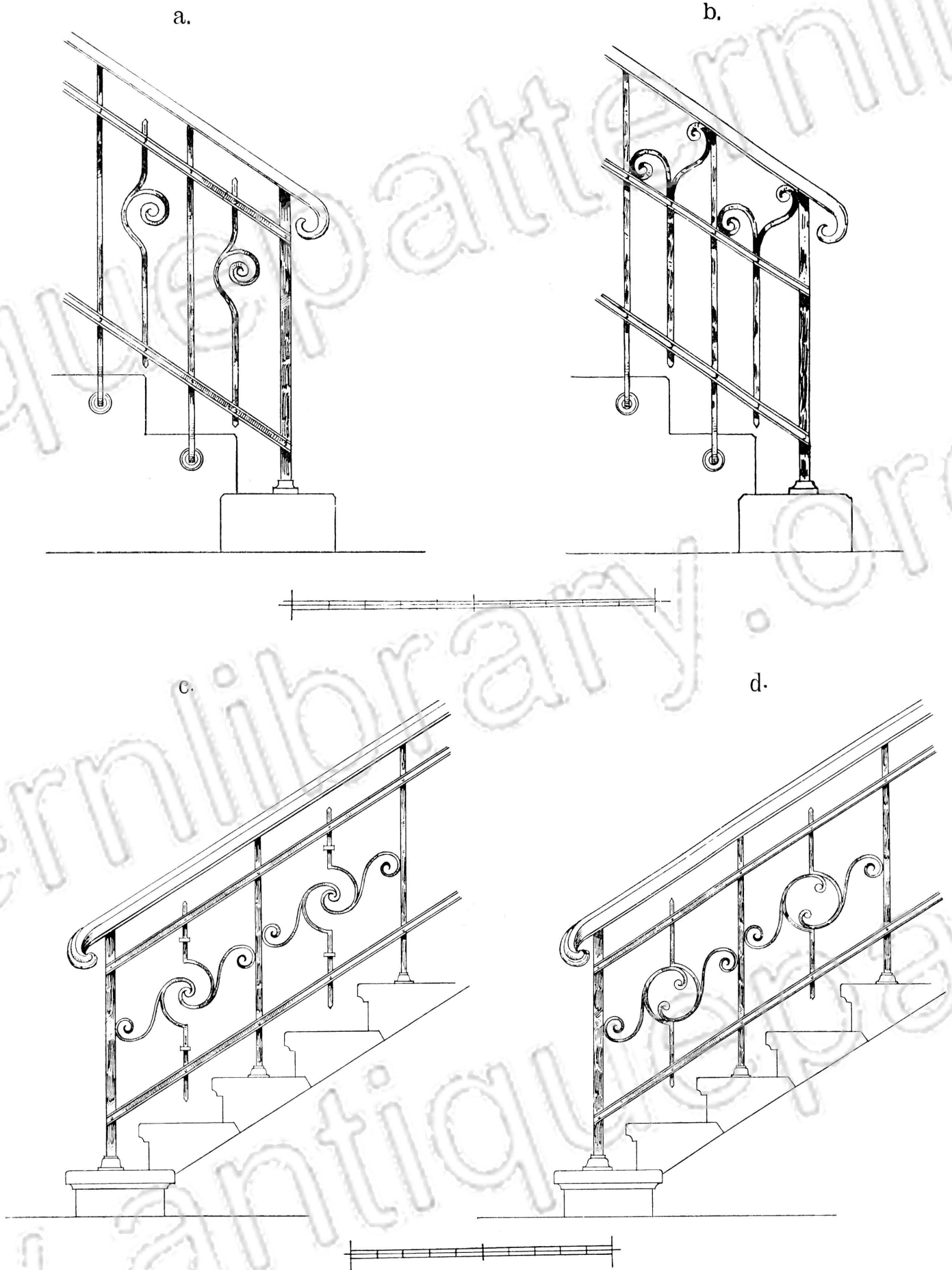

EINFACHE SCHMIEDE-ARBEITEN FÜR STADT UND LAND.

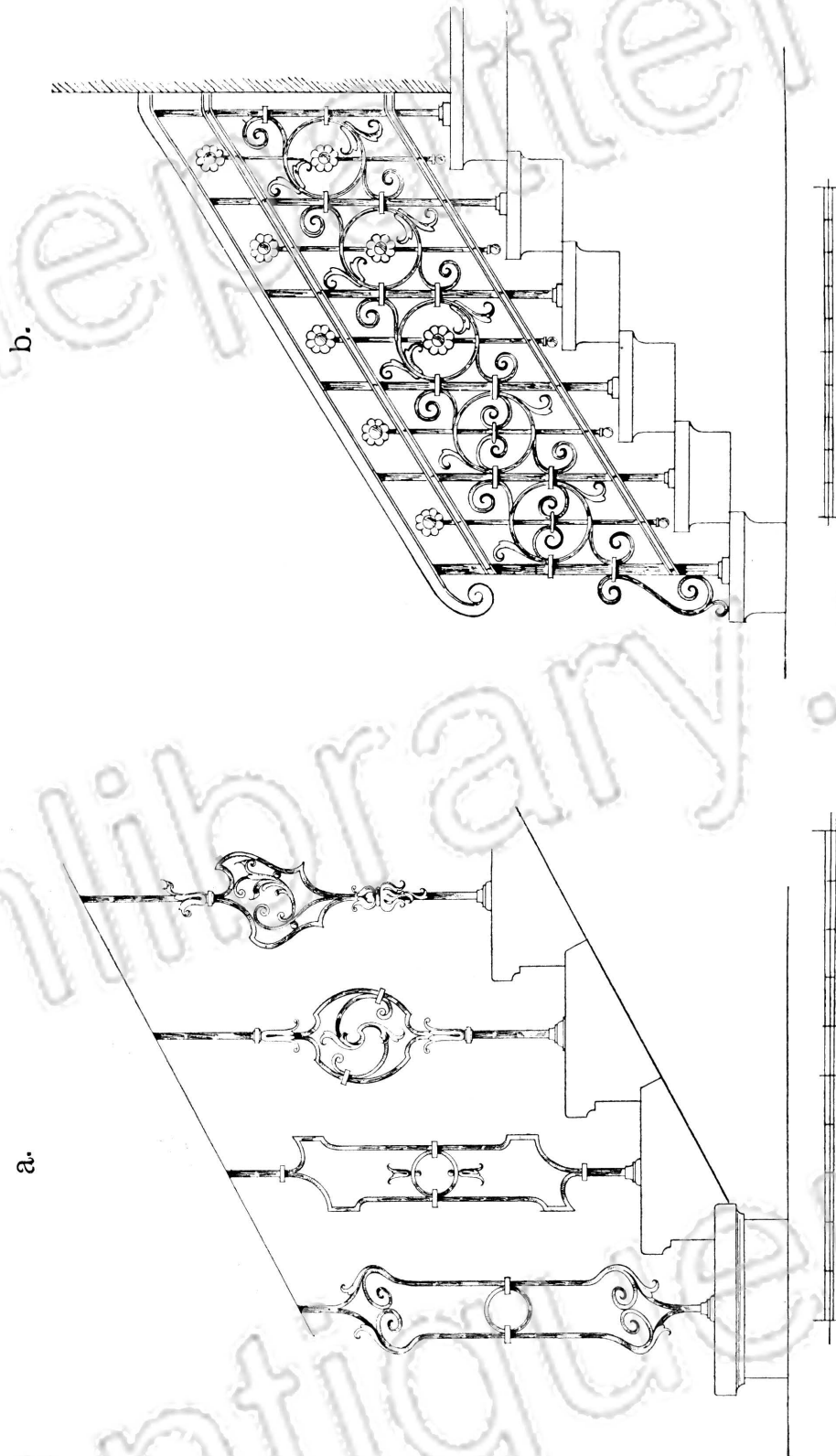

EINFACHE SCHMIEDE-ARBEITEN FÜR STADT UND LAND.

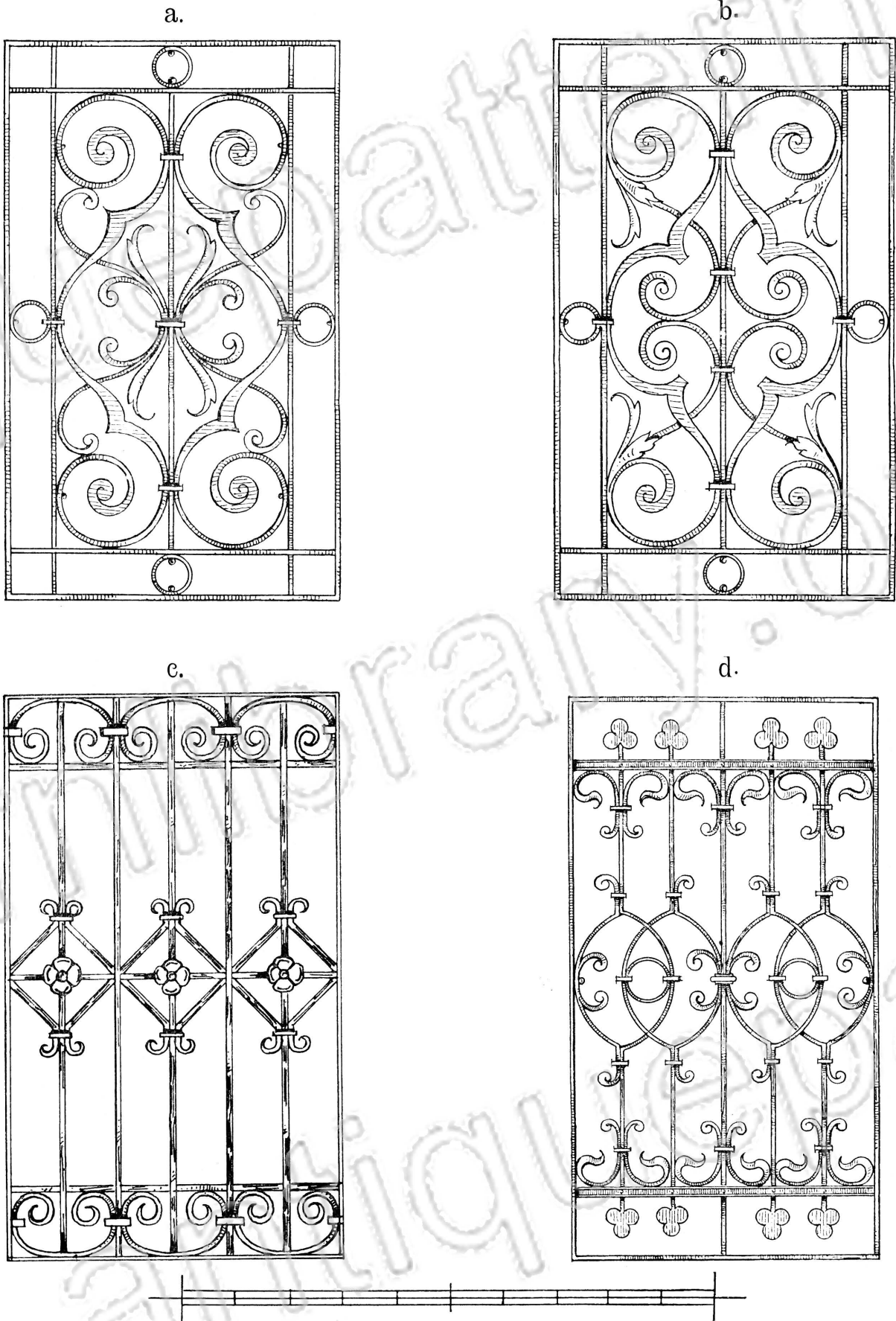

antiquepatternlib  
ernlibary.org  
www.antiquepat